



LINETRAXX® RCMA420

Residual current monitor

for monitoring AC and (pulsed) DC currents $I_{\Delta n} = 10 \dots 500 \text{ mA}$

in TN and TT systems



Table of contents

1	General information.....	5
1.1	How to use the manual.....	5
1.2	Indication of important instructions and information.....	5
1.3	Signs and symbols.....	5
1.4	Service and Support.....	5
1.5	Training courses and seminars.....	6
1.6	Delivery conditions.....	6
1.7	Inspection, transport and storage.....	6
1.8	Warranty and liability.....	6
1.9	Disposal of Bender devices.....	7
1.10	Safety.....	7
2	Function.....	8
2.1	Intended use.....	8
2.2	Device features.....	8
2.3	Function.....	8
2.3.1	Connection monitoring.....	9
2.3.2	Fast response value query.....	9
2.3.3	Automatic self test.....	9
2.3.4	Manual self test.....	9
2.3.5	Functional faults.....	9
2.3.6	Set the number of reload cycles.....	9
2.3.7	Assigning alarm categories to alarm relays K1/K2.....	9
2.3.8	Time delays t , t_{on} and t_{off}	9
2.3.9	Residual current monitoring in window discriminator mode.....	10
2.3.10	Password protection (on, OFF).....	10
2.3.11	Factory setting FAC.....	10
2.3.12	Erasable history memory.....	10
2.3.13	External, combined test/reset button T/R.....	10
2.3.14	Fault memory.....	10
3	Installation, connection and commissioning.....	11
3.1	Wiring.....	11
3.2	Commissioning.....	12

4	Operation and setting	13
4.1	Display elements in use.....	13
4.2	Function of the operating elements.....	14
4.3	Menu structure.....	14
4.4	Display in standard mode.....	16
4.5	Display in menu mode.....	16
5	Parameter settings	18
5.1	Response value setting for overcurrent.....	18
5.2	Fault memory.....	19
5.3	Alarm relays.....	19
5.4	Alarm categories.....	20
5.5	Set the time delays.....	21
5.6	Changeover: overcurrent/undercurrent/window mode.....	22
5.7	Password protection.....	22
5.8	Factory settings.....	24
5.9	Device information query.....	24
5.10	History memory query.....	24
6	Technical Data	25
6.1	Factory settings.....	25
6.2	Error codes.....	25
6.3	Tabular data.....	25
6.4	Standards, approvals and certifications.....	29
6.5	Ordering information.....	29
6.6	Document revision history.....	30

1 General information

1.1 How to use the manual

**ADVICE**

This manual is intended for qualified personnel working in electrical engineering and electronics! Part of the device documentation in addition to this manual is the enclosed supplement 'Safety instructions for Bender products'.

**ADVICE**

Read the operating manual before mounting, connecting and commissioning the device. Keep the manual within easy reach for future reference.

1.2 Indication of important instructions and information

**DANGER**

Indicates a high risk of danger that will result in death or serious injury if not avoided.

**WARNING**

Indicates a medium risk of danger that can lead to death or serious injury if not avoided.

**CAUTION**

Indicates a low-level risk that can result in minor or moderate injury or damage to property if not avoided.

**ADVICE**

Indicates important facts that do not result in immediate injuries. They can lead to malfunctions if the device is handled incorrectly.



Information can help to optimise the use of the product.

1.3 Signs and symbols



Disposal



Protect from moisture



Protect from dust

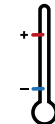

Temperature range



Recycling



RoHS directives

1.4 Service and Support

Information and contact details about customer service, repair service or field service for Bender devices are available on the following website: Fast assistance | Bender GmbH & Co. KG.

1.5 Training courses and seminars

Regular face-to-face or online seminars for customers and other interested parties:

www.bender.de > know-how > seminars.

1.6 Delivery conditions

The conditions of sale and delivery set out by Bender GmbH & Co. KG apply. These can be obtained in printed or electronic format.

The following applies to software products:



'Software clause in respect of the licensing of standard software as part of deliveries, modifications and changes to general delivery conditions for products and services in the electrical industry'

1.7 Inspection, transport and storage

Check the shipping and device packaging for transport damage and scope of delivery. In the event of complaints, the company must be notified immediately, see 'www.bender.de > service & support.'

The following must be observed when storing the devices:

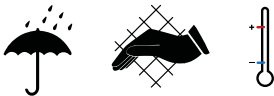

1.8 Warranty and liability

Warranty and liability claims for personal injury and property damage are excluded in the case of:

- Improper use of the device.
- Incorrect mounting, commissioning, operation and maintenance of the device.
- Failure to observe the instructions in this operating manual regarding transport, commissioning, operation and maintenance of the device.
- Unauthorised changes to the device made by parties other than the manufacturer.
- Non-observance of technical data.
- Repairs carried out incorrectly.
- The use of accessories or spare parts that are not provided, approved or recommended by the manufacturer.
- Catastrophes caused by external influences and force majeure.
- Mounting and installation with device combinations not approved or recommended by the manufacturer.

This operating manual and the enclosed safety instructions must be observed by all persons working with the device. Furthermore, the rules and regulations that apply for accident prevention at the place of use must be observed.

1.9 Disposal of Bender devices

Abide by the national regulations and laws governing the disposal of this device.



For more information on the disposal of Bender devices, refer to www.bender.de > service & support.

1.10 Safety

If the device is used outside the Federal Republic of Germany, the applicable local standards and regulations must be complied with. In Europe, the European standard EN 50110 applies.



DANGER *Risk of fatal injury due to electric shock!*

Touching live parts of the system carries the risk of:

- Risk of electrocution due to electric shock
- Damage to the electrical installation
- Destruction of the device

Before installing the device and before working on its connections, make sure that the installation has been de-energised. The rules for working on electrical systems must be observed.

2 Function

2.1 Intended use

The AC/DC sensitive residual current monitor RCMA420 is designed for use in earthed systems (TN and TT systems) where DC and AC fault currents may occur.

These are in particular loads containing six-pulse rectifiers or one way rectifiers with smoothing, such as converters, battery chargers, construction site equipment with frequency-controlled drives. Two separately adjustable response ranges allow to distinguish between prewarning ($I_{\Delta n1} = 50 \dots 100\%$ of the set response value $I_{\Delta n2}$) and alarm ($I_{\Delta n2}$). Since the values are measured with measuring current transformers, the RCMA is nearly independent of the nominal voltage and the load current of the system being monitored.

In order to meet the requirements of the applicable standards, customised parameter settings must be made on the equipment in order to adapt it to local equipment and operating conditions. Please heed the limits of the range of application indicated in the technical data. Any use other than that described in this manual is regarded as improper.

2.2 Device features

- AC/DC sensitive residual current monitor Type B according to IEC 62020 and IEC 60755
- Two separately adjustable response ranges (prewarning, alarm)
- Adjustable switching hysteresis
- R.m.s. value measurement
- Starting delay, response delay and delay on release
- Measured value display via multi-functional LC display
- Alarm indication via LEDs (AL1, AL2) and changeover contacts (K1, K2)
- N/C operation or N/O operation selectable
- Password protection against unauthorized parameter changing
- Fault memory function can be switched off
- CT connection monitoring

2.3 Function

Once the supply voltage U_S is applied, the starting delay is activated. Measured values changing during this time do not influence the switching state of the alarm relays.

Residual current measurement takes place via an external measuring current transformer CTUB101- CTBC20... 60.

The currently measured value is shown on the LC display. In this way any changes, for example when circuits are connected to the system, can be recognized easily.

If the measured value exceeds one or both response values, the response delays $t_{on1/2}$ start running. Once the response delay $t_{on1/2}$ has elapsed, the K1/ K2 alarm relays switch and the alarm LEDs AL1/AL2 light up.

If the residual current falls below the release value (response value minus hysteresis), the delay on release t_{off} begins. Once the release delay t_{off} has elapsed, the alarm relays return to their original state and the alarm LEDs AL1/AL2 go out. If the fault memory is activated, the alarm relays remain in the alarm state and the LEDs light until the reset button is pressed or until the supply voltage is interrupted.

The device function can be tested using the test button. The parameterization of the device can be carried out via the LC display and the function keys integrated in the front plate and can be password-protected.

2.3.1 Connection monitoring

The CT connections are continuously monitored. In the event of a fault, the alarm relays K1 / K2 switch without delay, the alarm LEDs AL1 / AL2 / ON flash (Error Code E.01). After eliminating the fault, the alarm relays automatically return to their initial position, provided that the fault memory M is deactivated. With the fault memory activated, K1/K2 return to their initial position by pressing the reset button R. A second cascaded measuring current transformer will not be monitored.

2.3.2 Fast response value query

With the display in standard mode, the currently measured response values $I_{\Delta n1}$ and $I_{\Delta n2}$ can be queried pressing the Up and Down keys (< 1.5 s). Switchover to the Menu mode is not required. If you want to exit the fast response value query, press the enter key.

2.3.3 Automatic self test

The device automatically carries out a self test after connecting to the system to be monitored and later every 24 hours. During the self test internal functional faults will be detected and appear in form of an error code on the display.

The alarm relays are not checked during this test.

2.3.4 Manual self test

After pressing the test button for > 1.5 s, the device carries out a self test. During this test, internal functional faults are detected and will be displayed in form of an error code. The alarm relays are not checked during this test.

While the test button T is pressed and held down, all device-related display elements appear on the display.

2.3.5 Functional faults

If an internal functional fault occurs, all three LEDs flash. An error code will appear on the display (E01...E32). In such a case please contact the Bender Service.

2.3.6 Set the number of reload cycles

If faults occur only temporarily, but recurrently, in the system being monitored, with the fault memory M deactivated, the alarm relays would switch synchronously to the error status. RL in the out menu can be used to limit the number of these changeover processes. As soon as the preset number of switching cycles is exceeded, the fault memory will come on and an activated alarm remains stored.

2.3.7 Assigning alarm categories to alarm relays K1/K2

The alarm categories device error, residual current $I_{\Delta n1}$, residual current $I_{\Delta n2}$ or alarm by device test can be assigned to the alarm relays via the 'out' menu.

2.3.8 Time delays t , t_{on} and t_{off}

The times t , t_{on} and t_{off} described below, delay the output of alarms via LEDs and relays.

Starting delay t

After connection to the supply voltage, the alarm indication is delayed by the preset time t (0...10 s).

Response delay $t_{on1/2}$

If the residual current increases above or falls below the response value the response time t_{an} expires. After the expiry of the response time an alarm is signalled. A set response delay $t_{on1/2}$ (0...10 s) adds up to the device-related operating time t_{ae} and delays alarm signalling (total delay time $t_{an} = t_{ae} + t_{on}$).

If the residual current fault changes from a value above the response value to a value below the response value, an alarm will not be signalled.

Delay on release t_{off}

When no alarm exists after deactivating the fault memory, the alarm LEDs go out and the alarm relays switch back to their initial position. After activating the delay on release (0...99 s), the alarm state is continuously maintained for the selected period.

2.3.9 Residual current monitoring in window discriminator mode

Change the measuring principle by selecting the window mode (SEt / In). In the window discriminator mode, the threshold values I1 and I2 represent the upper and the lower value. If the measured value is not within this area, an alarm is initiated by the device.

2.3.10 Password protection (on, OFF)

When the password protection is activated (on), settings are only possible after entering the correct password (0...999).

2.3.11 Factory setting FAC

After activating the factory setting, all settings previously changed are reset to delivery status.

2.3.12 Erasable history memory

The first alarm value that occurs will be saved in this memory. The memory can be cleared via the menu HiS.

2.3.13 External, combined test/reset button T/R

Reset = Pressing the external button < 1.5 s

Test = Pressing the external button > 1.5 s

2.3.14 Fault memory

The fault memory can be activated, deactivated or set to continuous mode (con). If the fault memory is set to 'con' mode, the alarm parameters remain stored even on failure of the supply voltage. Stored alarms can be reset by means of the reset button R.

3 Installation, connection and commissioning



Only skilled persons are permitted to carry out the work necessary to install, put into service and run a device or system.



DANGER Risk of fatal injury due to electric shock!

Touching live parts of the system carries the risk of:

- Risk of electrocution due to electric shock
- Damage to the electrical installation
- Destruction of the device

Before installing the device and before working on its connections, make sure that the installation has been de-energised. The rules for working on electrical systems must be observed.

Dimension diagram, drawing for screw mounting, push-wire terminal connection

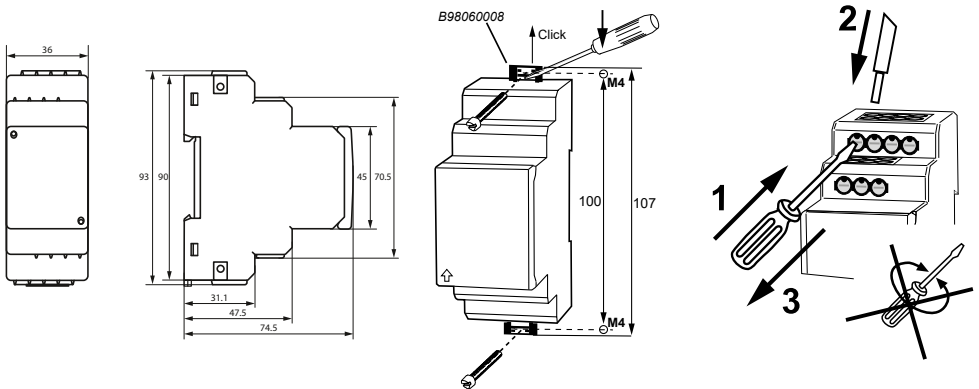

All dimensions in mm.

The front plate cover is easy to open at the lower part marked by an arrow.

Mounting

DIN rail mounting

Snap the rear mounting clip of the device into place in such a way that a safe and tight fit is ensured.

Screw fixing

Use a tool to move the rear mounting clips (a second mounting clip required, see ordering information) to a position that it projects beyond the enclosure. Then fix the device using two M4 screws.

3.1 Wiring

Connect the device according the wiring diagram.

Observe the manuals of the respective measuring current transformer.

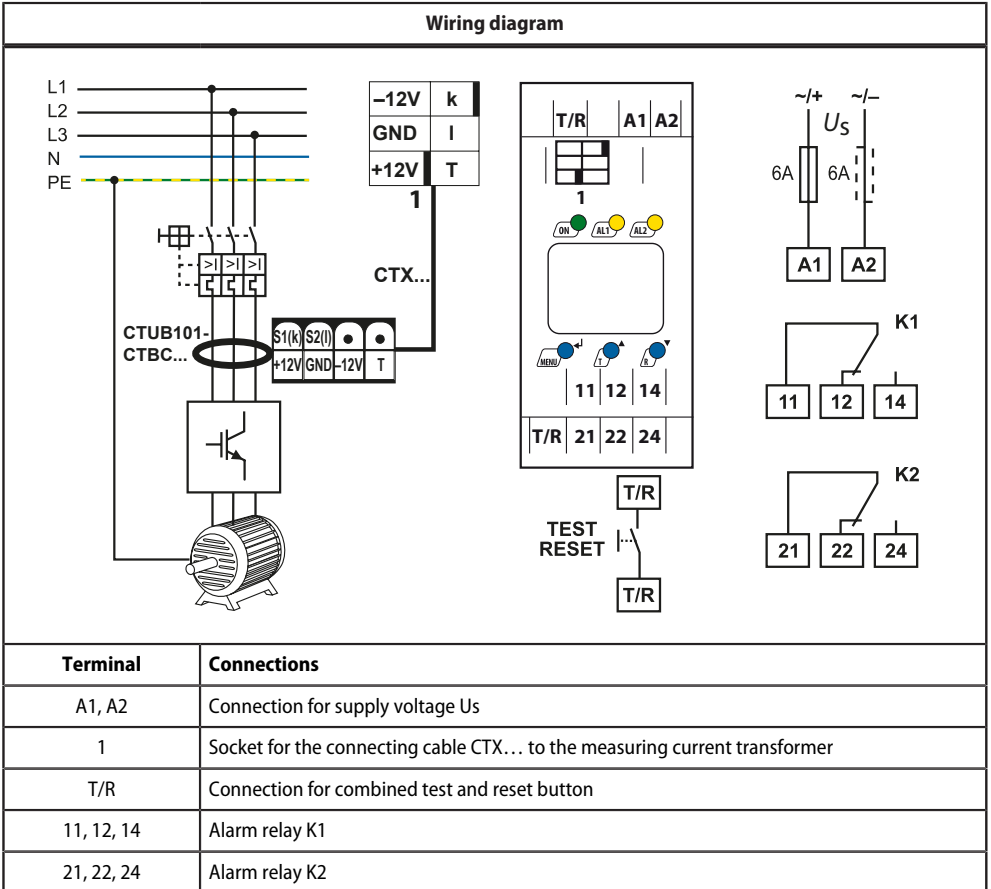

3.2 Commissioning

Prior to commissioning, check proper connection of the residual current monitor.



4 Operation and setting

4.1 Display elements in use

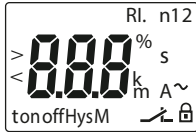
A detailed description of the meaning of the display elements in use is given in the table below.



Display-Elemente

Element	Function
RL	Reload function with memory = off (L = I.)
I2	Response value $I_{\Delta n2}$ as mA (Alarm 2, main alarm)
I1	Response value $I_{\Delta n1}$ as % of $I_{\Delta n2}$ (Alarm 1, prewarning)
r1, 1 r2, 2	Alarm relay K1 Alarm relay K2
I Hys, %	Response value hysteresis as %
ton1 ton2 t toff	Response delay t_{on1} (K1) Response delay t_{on2} (K2) Starting delay t Delay on release t_{off} (K2)
M	Fault memory active
	Relay operating mode K2
	Password protection enabled

4.2 Function of the operating elements

Operating elementes

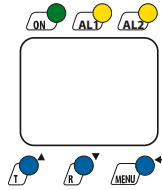



Element	Function
ON, green	LED ON lighting continuously: Power On Flashing LED ON: System fault or connection monitoring fault
AL1, yellow	LED AL 1 lights: Response value 1 reached ($I_{\Delta n1}$)
AL2, yellow	LED AL 2 lights: Response value 2 reached ($I_{\Delta n2}$)
T	Test button (> 1.5 s): To indicate the available display elements, to start a self test
R	Reset button (> 1.5 s): Deleting the fault memory
▲ ▼	Up/Down key (< 1.5 s): Menu items/values
MENU	MENU key (> 1.5 s): Starting the menu mode
↵	Enter key (< 1.5 s): Confirm menu item, submenu item and value. Enter key (> 1.5 s): Back to the next higher menu level.

4.3 Menu structure

All adjustable parameters are listed in the columns 'menu item' and 'adjustable parameters'. A display-like representation is used to illustrate the parameters in the column menu item. Different alarm categories can be assigned to the alarm relays K1, K2 via the submenus r1, r2. This is done by activation or deactivation of the respective function.

Menu	Sub menu	Menu item	Activation	Adjustable parameter
AL (response values)	→	>I2	- (HI)	$I_{\Delta n2}$ (alarm2, main alarm)
		>I1	- (HI)	$I_{\Delta n1}$ as % of $I_{\Delta n2}$ (alarm 1, prewarning)
		Hys	-	Hysteresis $I_{\Delta n1} / I_{\Delta n2}$

Menu	Sub menu	Menu item	Activation	Adjustable parameter
out (output control)	→	M	ON	Fault memory
		 1	-	Operating mode K1 (n.c.)
		 2	-	Operating mode K2 (n.c.)
		RL	-	Reload function (memory = off)
	r1 (K1: assignment alarm category)	1 Err	ON	Device error at K1
		r1 I1	ON	Prewarning $I_{\Delta n1}$ at K1
		r1 I2	OFF	Main alarm $I_{\Delta n2}$ at K1
		1 tES	ON	Device test
	r2 (K2: assignment alarm category)	2 Err	ON	Device error at K2
		r2 I1	OFF	Prewarning $I_{\Delta n1}$ at K2
		r2 I2	ON	Main alarm $I_{\Delta n2}$ at K2
		2 tES	ON	Device test
t (timing check)	→	t on 1	-	Response delay K1
		t on 2	-	Response delay K2
		t	-	Starting delay
		t off	-	Delay on release K1/K2
Set (device control)	→	I 12	HI	Selectable parameters: High (HI), window function (In), low (Lo)
			OFF	Parameter setting via password
		FAC	-	Restore factory settings
		SYS	-	Function blocked
InF	→	-	-	Display hardware and software version
HiS	→	Clr	-	History memory for the first alarm value, erasable

4.4 Display in standard mode

By default, the currently measured residual current is displayed. The current response values I1 (prewarning) and I2 (alarm) can be displayed using the Up and Down key. Press the Enter key to return to the measured value.

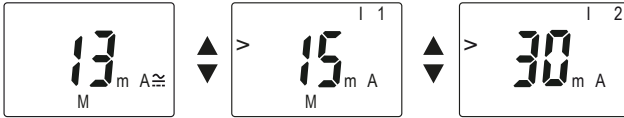

i In the standard mode, the currently set response values I1 and I2 can be displayed using the Up and Down keys.

4.5 Display in menu mode

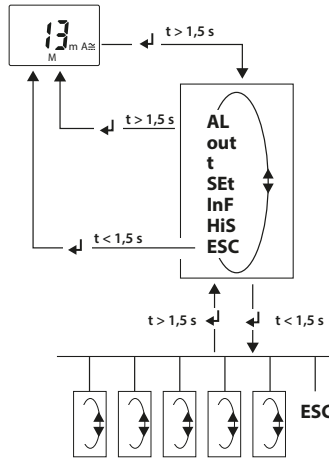

Parameter query and setting: overview

Menu item	Adjustable parameter
AL	Response values query and setting <ul style="list-style-type: none"> Residual current I2 ($I_{\Delta n2}$) (AL2) Residual current I1 ($I_{\Delta n1}$) (AL1) Hysteresis of the response: % Hys

Menu item	Adjustable parameter
OUT	Configuration of the fault memory and the alarm relays <ul style="list-style-type: none"> • Activate/deactivate the fault memory or assign continuous mode (on/off/con) • Select N/O operation (n.o.) or N/C operation (n.c.) individually for each K1/K2 • Specify the number of the reload cycles • Assign the alarm category I1 ($I_{\Delta n1}$) or I2 ($I_{\Delta n2}$), relay test or device error individually to K1/K2 (1, r1/2, r2).
T	Set delays <ul style="list-style-type: none"> • Response delay t_{on1}/t_{on2} • Starting delay t • Delay on release t_{off} (LED, relay)
SEt	Device control parameter setting <ul style="list-style-type: none"> • Select the appropriate parameter for response values: overcurrent mode (HI), undercurrent mode (Lo) or window mode (In). • Enable or disable password protection, change the password. • Restore factory settings. • Service menu SyS blocked
InF	Query hard and software version
HiS	Query the first stored alarm value
ESC	Move to the next higher menu level (back)

5 Parameter settings

An example is given here on how to change the alarm response value I_1 ($I_{\Delta n1}$). It is presumed that the option overcurrent (HI) has been selected in the SEt/I 12 menu (factory setting). Proceed as follows:

1. Press the MENU/Enter key for more than 1.5 seconds. The flashing short symbol **AL** appears on the display.
2. Confirm with Enter. The parameter response value **> I2** flashes, in addition the associated overcurrent value **> 30 mA** appears.
3. Use the Down key to select the parameter response value **I1**. The parameter **> I1** flashes, in addition the associated percentage value for prewarning **50 % of I2** appears.
4. Confirm with Enter. The current value for prewarning appears on the flashing display.
5. Use the Up or Down key to set the appropriate prewarning value. Confirm with Enter. **I1** flashes.
6. You can exit the menu by:
 - pressing the Enter key for more than 1.5 seconds or
 - selecting the menu item ESC and confirming with Enter to reach the next higher level.

i The currently active segments are flashing! In the figures below, the segments where device settings can be carried out are highlighted by an oval. The menu mode can be reached by pressing the **MENU** key for more than 1.5 seconds.

5.1 Response value setting for overcurrent

Increasing the response value I2 (main alarm overcurrent $I_{\Delta n2}$)

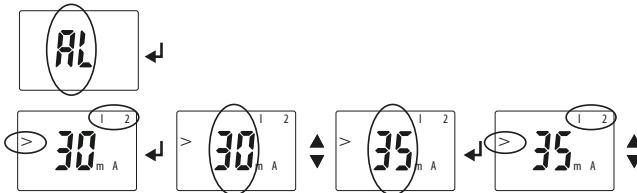

Increasing the response value I1 (prewarning overcurrent $I_{\Delta n1}$)

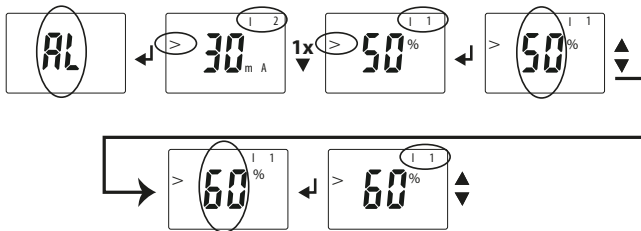

Setting the hysteresis of the response values $I_{\Delta n1}$, $I_{\Delta n2}$

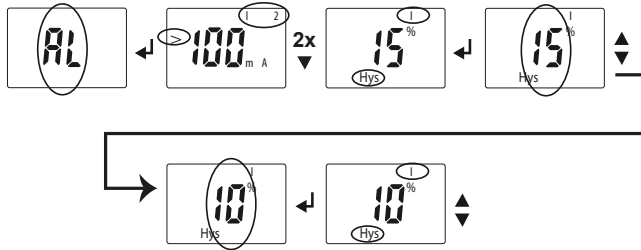

5.2 Fault memory

Setting the fault memory to con mode

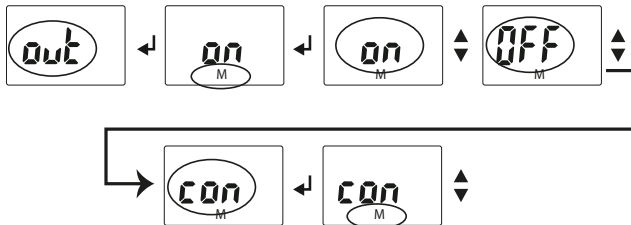

5.3 Alarm relays

Setting the alarm relay K1 to N/O operation (n.o.)

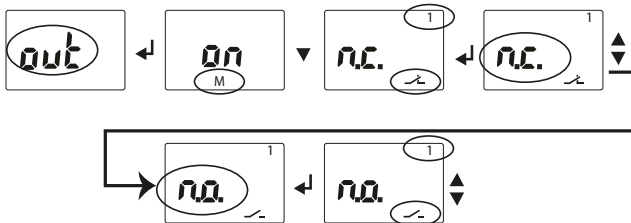

Setting the number of reload cycles

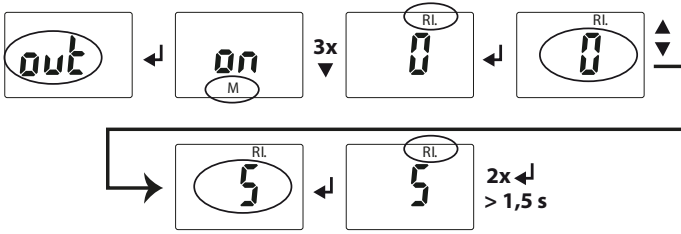

5.4 Alarm categories

Overcurrent, undercurrent and device-related errors of the residual current monitor can be assigned to the alarm relays K1 (r1, 1) and K2 (r2, 2). By default, the alarm relays K1 and K2 signal prewarning and alarm in case of overcurrent and device-related errors.

Alarm relay K1: Deactivating the category device error

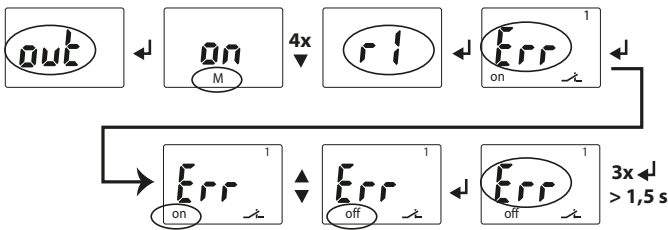

Alarm relay K1: Deactivating the category response value I1

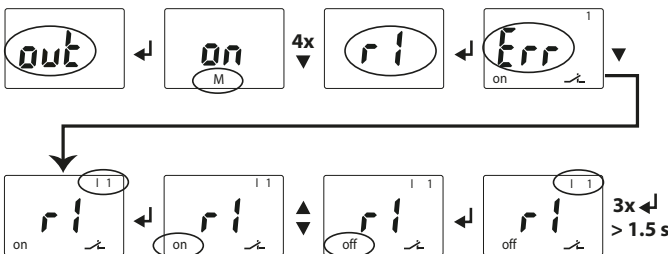

Alarm relay K1: Activating the category response value I2

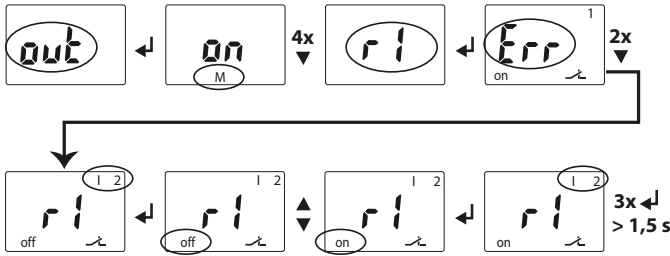

Alarm relay K1: Deactivating the category 'Alarm by device test'

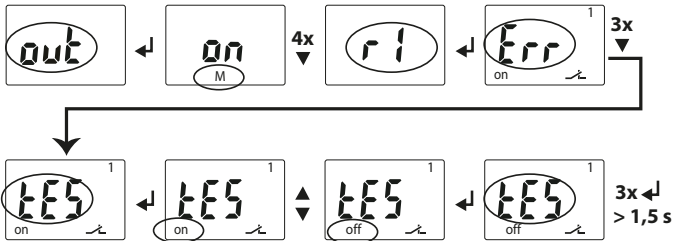

CAUTION

When an alarm relay (K1/K2) has been deactivated in the menu, an alarm will not be signalled by the respective changeover contact! An alarm will only be indicated by the respective alarm LED (AL1/AL2)!

5.5 Set the time delays

The following delays can be set

- Response delay t_{on1} (0... 10 s) for K1, and t_{on2} (0... 10 s) for K2
- Starting delay t (0... 10 s) when the device is being started
- Common delay on release t_{off} (0... 99 s) for K1, K2. The setting t_{off} is only relevant when the fault memory M is deactivated.

The operating steps for the setting of the response delay t_{on1} and the starting delay t are illustrated by way of example.

Setting the response delay t_{on1}

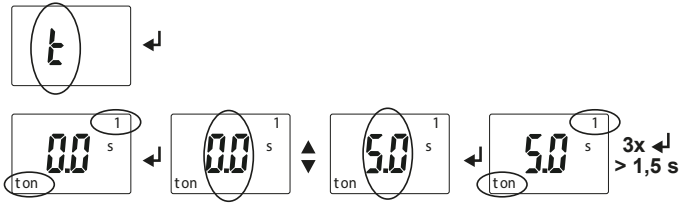

Setting the starting delay t

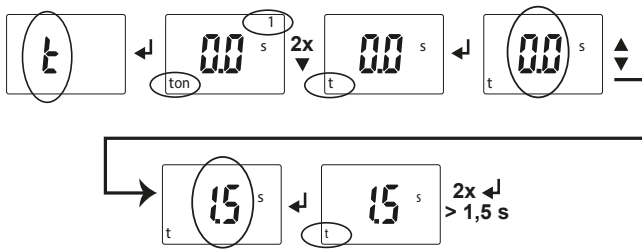

5.6 Changeover: overcurrent/undercurrent/window mode

The operating mode can be changed in the SEt/I 12 menu using the parameters HI, Lo and In. By default, overcurrent operation (HI) is set.

Changing from overcurrent operation to window operation

Use this menu item to set whether the response values of the device apply to overcurrent (HI) or undercurrent operation (Lo). In addition, window operation (In) can be selected.

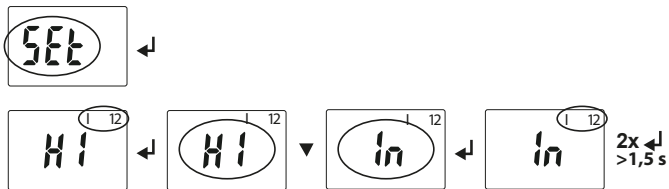

5.7 Password protection

Use this menu to activate the password protection, to change the password or to deactivate the password protection.

Activating the password protection

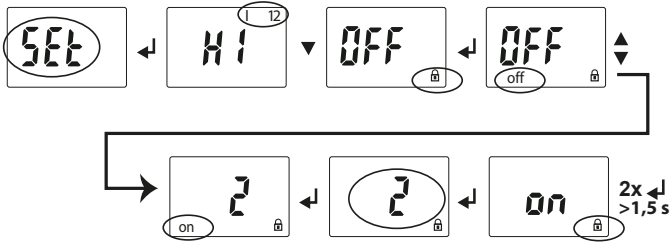

Changing the password

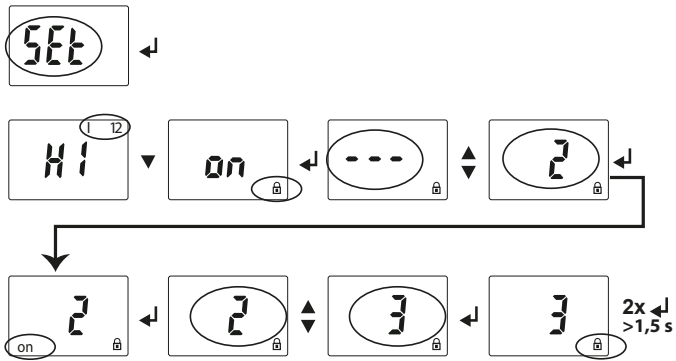

Deactivating the password protection

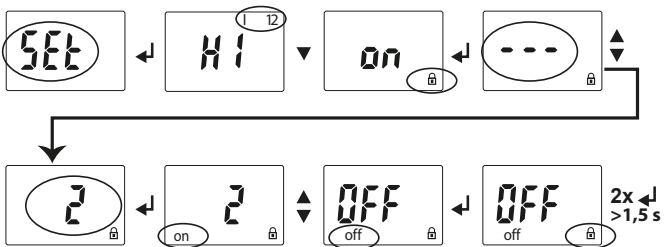

5.8 Factory settings

In this menu you can reset the device to its factory settings.

Restoring factory settings

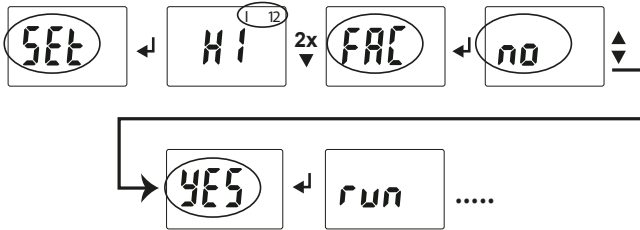

5.9 Device information query

Example

This function is used to query the software (1.xx) version. After activating this function, data will be displayed as a scrolling text. Once one pass is completed you can select individual data sections using the Up/Down keys.

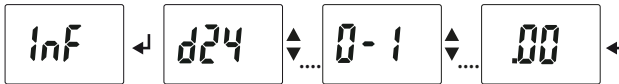

5.10 History memory query

The history memory can be selected via the menu HiS. Use the Up and Down keys to view the next display. If Clr and M is flashing, the history memory can be cleared by pressing the Enter key.



6 Technical Data

6.1 Factory settings

Response value overcurrent I1 (prewarning)	15 mA (50 % of I2)
Response value overcurrent I2 (main alarm)	30 mA
Hysteresis	15 %
Fault memory M	activated (on)
Operating mode K1/K2	N/C operation (n.c.)
Starting delay	$t = 0.5 \text{ s}$
Response delay	$t_{\text{on1}} = 1 \text{ s}$ $t_{\text{on2}} = 0 \text{ s}$
Delay on release	$t_{\text{off}} = 1 \text{ s}$
Password	0, deactivated (off)

6.2 Error codes

Should, contrary to all expectations, a device error occur, error codes will appear on the display. Typical error codes are described below:

Error code	Meaning
E.01	Fault CT connection monitoring Appropriate action: Check CT connection for short-circuit or interruption. After eliminating the fault, the error code will be automatically deleted.
E.02	Fault CT connection monitoring during manual self test. Appropriate action: Check CT connection for short-circuit or interruption. After eliminating the fault and anew self-test or anew device start, the error code will be automatically deleted.
E...	Appropriate action when error codes > 02 occur: Carry out a reset. Reset the device to factory setting. After eliminating the fault, the error code will be automatically deleted. If the fault continues to exist, please contact the Bender Service

6.3 Tabular data

()* = factory setting

Insulation coordination acc. to IEC 60664-1/IEC 60664-3

RCMA42x-D-1	Rated insulation voltage	100 V
	Overvoltage category/pollution degree	III/3
	Rated impulse voltage	2.5 kV
RCMA42x-D-2	Rated insulation voltage	250 V
	Overvoltage category/pollution degree	III/3
	Rated impulse voltage	4 kV

Supply voltage

RCMA420-D-1	Supply voltage range U_s	AC 24...60 V / DC 24...78 V
	Operating range U_s	AC 16...72 V / DC 9.6...94 V
	Frequency range U_s	DC, 42...460 Hz
RCMA420-D-2	Supply voltage range U_s	AC/DC 100...250 V
	Operating range U_s	AC/DC 70...300 V
	Frequency range U_s	DC, 42...460 Hz
Protective separation (reinforced insulation) between		(A1, A2) - (k/l, T/R) - (11, 12, 14) - (21, 22, 24)
Voltage test according to IEC 61010-1		2.21 kV
Power consumption		≤ 6.5 VA

Measuring circuit

External measuring current transformer type		CTUB101-CTBC20...60
Rated insulation voltage (measuring current transformer)		800 V
Operating characteristic acc. to IEC 62020-1 and IEC 60755		Typ B
Frequency range		0...2000 Hz
Measuring range AC		0...1.5 A
Measuring range DC		0...600 mA
Relative uncertainty at	$f \leq 2$ Hz	0...-35 %
	$f > 2... < 16$ Hz	-35...+100 %
	$f \geq 16... \leq 1000$ Hz	0...-35 %
	$f > 1000... \leq 2000$ Hz	±35 %
Operating uncertainty		±17.5 %

Response values

Rated residual operating current $I_{\Delta n1}$ (prewarning, AL1)	50...100 % $\times I_{\Delta n2}$ (50 %)*
Rated residual operating current $I_{\Delta n2}$ (main alarm, AL2)	AC / DC 10...500 mA (30 mA)*
Hysteresis	10...25 % (15 %)*

Specified time

Starting delay t	0...10 s (0.5 s)*
Response delay t_{on1} (prewarning)	0...10 s (1 s)*
Response delay t_{on2} (main alarm)	0...10 s (0 s)*
Delay on release t_{off}	0...99 s (1 s)*
Operating time t_{ae} at $I_{\Delta n} = 1 \times I_{\Delta n1/2}$	≤ 180 ms
Operating time t_{ae} at $I_{\Delta n} = 5 \times I_{\Delta n1/2}$	≤ 30 ms
Response time t_{an}	$t_{an} = t_{ae} + t_{on1/2}$
Recovery time t_b	≤ 300 ms
Number of reload cycles	0...100 (0)*

Displays, memory

Display range, measured value AC	0...1.5 A
Display range, measured value DC	0...600 mA
Error of indication	± 17.5 % / ± 2 digit
Measured-value memory for alarm value	data record measured values
Password	off / 0...999 (off)*
Fault memory alarm relay	on / off (on)*

Inputs/outputs

Cable length for external test / reset button	0...10 m
---	----------

Cable lengths for measuring current transformers

Connection CTX...	1 m / 2.5 m / 5 m / 10 m
or alternatively: single wire 6 x 0.75 mm ²	0...10 m

Switching elements

Number of switching elements	2 x 1 changeover contact				
Operating principle	N/C operation/N/O operation (N/C operation)*				
Electrical service life under rated operating conditions	10000 switching operations				
Minimum contact load (relay manufacturer's reference)	10 mA/5 V DC				
Contact data acc. to IEC 60947-5-1					
Utilization category	AC-13	AC-14	DC-12	DC-12	DC-12
Rated operational voltage	230 V	230 V	24 V	110 V	220 V
Rated operational voltage UL	200 V	200 V	24 V	110 V	200 V
Rated operational current	5 A	3 A	1 A	0.2 A	0.1 A

Environment/EMC

EMC	DIN EN 62020				
Operating temperature	-25...+55 °C				
Classification of climatic conditions IEC 60721 (except condensation and formation of ice)	Stationary use (IEC 60721-3-3)	3K22			
	Transportation (IEC 60721-3-2)	2K11			
	Storage (IEC 60721-3-1)	1K22			
Classification of mechanical conditions acc. to IEC 60721	Stationary use (IEC 60721-3-3)	3M11			
	Transportation (IEC 60721-3-2)	2M4			
	Storage (IEC 60721-3-1)	1M12			

Connection

For UL applications: Use 60/70 °C copper conductors only!

Connection type **screw-type terminals**

Connection properties	rigid/flexible	0.2...4 / 0.2...2.5 mm ² (AWG 24...12)
	multi-conductor connection (2 conductors with the same cross section) rigid/flexible	0,2...1,5 / 0,2...1,5 mm ² (AWG 24...16)
Stripping length	8...9 mm	
Tightening torque	0.5...0.6 Nm	

Connection type **push-wire terminals**

Connection

Connection properties	rigid	0.2...2.5 mm ² (AWG 24...14)
	flexible without ferrules	0.75...2.5 mm ² (AWG 19...14)
	flexible with ferrules	0,2...1,5 mm ² (AWG 24...16)
Stripping length		10 mm
Opening force		50 N
Test opening, diameter		2.1 mm

Other

Operating mode	continuous operation
Position of normal use	display oriented
Protection class, internal components (IEC 60529)	IP30
Protection class, terminals (IEC 60529)	IP20
Enclosure material	polycarbonate
Flammability class	UL94V-0
DIN rail mounting acc. to	IEC 60715
Screw mounting	2 x M4 with mounting clip
Software version	D242 V1.2x
Weight	≤ 150 g

(*) = factory setting

6.4 Standards, approvals and certifications

6.5 Ordering information

	RCMA420-D-1	RCMA420-D-2
Response range $I_{\Delta n}$	10...500 mA	
Rated frequency	0...2000 Hz	
Measuring current transformers	CTUB101-CTBC... series	
Supply voltage U_5^*	DC 9,6...94 V / AC 42...460 Hz, 16...72 V	DC 70...300 V / AC 42...460 Hz, 70...300 V

	RCMA420-D-1	RCMA420-D-2
Art. No. (B 7... = push-wire terminal)	B 7404 3001 B 9404 3001	B 7404 3002 B 9404 3002
*Absolute values of the voltage range		

External measuring current transformers

Typ	Innendurchmesser	geschirmt	Art. No.
CTUB101-CTBC20	ø 20 mm	—	B78120010
CTUB101-CTBC20P		X	B78120020
CTUB101-CTBC35	ø 35 mm	—	B78120012
CTUB101-CTBC35P		X	B78120022
CTUB101-CTBC60	ø 60 mm	—	B78120014
CTUB101-CTBC60P		X	B78120024

Measuring current transformer connecting cable

Type	Length (m)	Art. No.
CTX-100	1	B98110080
CTX-250	2,5	B98110081
CTX-500	5	B98110082
CTX-1000	10	B98110083

RCMA42... accessories

	Art.-Nr.
Montageclip für Schraubmontage (1 Stück je Gerät)	B98060008

6.6 Document revision history

Date	Document version	State/Changes
03.2020	03	<i>Editorial revision</i> - Wiring diagram - Relative uncertainty for <i>f</i> - Ordering information CTUB...
05.2021	04	<i>Editorial revision</i> - Terms prewarning + main alarm - min. contact load <i>Added</i> UKCA logo

Date	Document version	State/Changes
12.2023	05	<i>Editorial revision</i> Layout of the document



Bender GmbH & Co. KG

Londorfer Straße 65
35305 Grünberg
Germany

Tel.: +49 6401 807-0
info@bender.de
www.bender.de

Alle Rechte vorbehalten.
Nachdruck und Vervielfältigung nur mit
Genehmigung des Herausgebers.

All rights reserved.
Reprinting and duplicating only with
permission of the publisher.



© Bender GmbH & Co. KG, Germany
Subject to change! The specified
standards take into account the edition
valid until 12.2023 unless otherwise
indicated.