



DC

# ISOMETER® isoCHA425

Insulation monitoring device

For unearthed DC systems 0 V to 400 V

Suitable for DC charging stations according to CCS or CHAdeMO

Software version: D0612 V4.xx





## Table of contents

<b>1</b>	<b>General information.....</b>	<b>5</b>
1.1	How to use this manual.....	5
1.2	Indication of important instructions and information.....	5
1.3	Signs and symbols.....	5
1.4	Service and Support.....	5
1.5	Training courses and seminars.....	5
1.6	Delivery conditions.....	6
1.7	Inspection, transport and storage.....	6
1.8	Warranty and liability.....	6
1.9	Disposal of Bender devices.....	6
1.10	Safety.....	7
<b>2</b>	<b>Function.....</b>	<b>8</b>
2.1	Intended use.....	8
2.2	Device features.....	8
2.3	Functional description.....	9
2.3.1	$R_F$ and $C_e$ in 'CHd' mode (CHAdEMO).....	9
2.3.2	$R_F$ and $C_e$ in 'dc' mode (CCS).....	10
2.3.3	Fault location R%.....	10
2.3.4	System leakage capacitance $C_e$ .....	10
2.3.5	System voltages $U_{nr}$ , $U_{L1e}$ and $U_{L2e}$ .....	10
2.3.6	Functional tests of contactors in the charging station and the vehicle.....	10
2.3.7	Monitoring the insulation resistance.....	11
2.3.8	Undervoltage/overvoltage monitoring.....	11
2.3.9	Stop mode.....	11
2.3.10	Self test functions (device errors).....	11
2.3.11	Alarm assignment of the alarm relays K1/K2.....	13
2.3.12	Fault memory.....	13
2.3.13	Digital interfaces.....	14
2.3.14	Measuring and response times.....	14
2.3.15	Password protection (on, OFF).....	15
2.3.16	External test/reset button (T/R).....	15
2.3.17	History memory HiS.....	15
<b>3</b>	<b>Installation, connection and commissioning.....</b>	<b>16</b>
3.1	Dimensions.....	16

3.2	Installation.....	16
3.3	Connection.....	16
3.4	Commissioning.....	18
<b>4</b>	<b>Operation.....</b>	<b>19</b>
4.1	Operating and display elements.....	19
4.2	Menu overview.....	21
4.3	Displaying measured values.....	22
4.4	Setting the response values (AL).....	23
4.4.1	Response values overview.....	23
4.4.2	Setting the insulation resistance parameters.....	23
4.4.3	Setting parameters for undervoltage and overvoltage.....	23
4.5	Configuring fault memory, alarm relays, and interfaces (out).....	24
4.5.1	Configuring the relays.....	24
4.5.2	Assigning the alarm messages to the relays.....	24
4.5.3	Activating or deactivating fault memory.....	25
4.5.4	Configuring interface.....	25
4.6	Setting delay times and self test cycles (t).....	26
4.7	Setting device control parameters (SEt).....	26
4.8	Reset to factory settings.....	27
4.9	Showing and deleting the history memory.....	27
4.10	Querying software version (InF).....	27
<b>5</b>	<b>Data access via RS-485 interface.....</b>	<b>28</b>
5.1	Data access using the BMS protocol.....	28
5.2	Data access using the Modbus RTU protocol.....	28
5.2.1	Reading out the Modbus register from the ISOMETER®.....	28
5.2.2	Writing the Modbus register (parameter setting).....	29
5.2.3	Exception code.....	30
5.3	Modbus register assignment.....	31
5.3.1	Modbus measured value registers.....	31
5.3.2	Modbus parameter register.....	34
5.4	IsoData data string.....	37
<b>6</b>	<b>Technical data.....</b>	<b>39</b>
6.1	Technical data isoCHA425.....	39
6.2	Standards and certifications.....	44
6.3	Ordering data.....	44
6.4	Document revision history.....	45

## 1 General information

### 1.1 How to use this manual



#### ADVICE

This manual is intended for qualified personnel working in electrical engineering and electronics! Part of the device documentation in addition to this manual is the enclosed supplement " Safety instructions for Bender products".



#### ADVICE

Read the operating manual before mounting, connecting and commissioning the device. Keep the manual within easy reach for future reference.

### 1.2 Indication of important instructions and information



#### DANGER

Indicates a high risk of danger that will result in death or serious injury if not avoided.



#### WARNING

Indicates a medium risk of danger that can lead to death or serious injury if not avoided.



#### CAUTION

Indicates a low-level risk that can result in minor or moderate injury or damage to property if not avoided.



*Information can help to optimise the use of the product.*

### 1.3 Signs and symbols



Disposal



Protect from moisture



Protect from dust

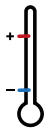

Temperature range



Recycling



RoHS directives

### 1.4 Service and Support

Information and contact details about customer service, repair service or field service for Bender devices are available on the following website: Fast assistance | Bender GmbH & Co. KG.

### 1.5 Training courses and seminars

Regular face-to-face or online seminars for customers and other interested parties:

[www.bender.de](http://www.bender.de) > know-how > seminars.

## 1.6 Delivery conditions

The conditions of sale and delivery set out by Bender GmbH & Co. KG apply. These can be obtained in printed or electronic format.

The following applies to software products:



'Software clause in respect of the licensing of standard software as part of deliveries, modifications and changes to general delivery conditions for products and services in the electrical industry'

## 1.7 Inspection, transport and storage

Check the shipping and device packaging for transport damage and scope of delivery. In the event of complaints, the company must be notified immediately, see "www.bender.de > service & support".

The following must be observed when storing the devices:

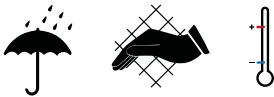

## 1.8 Warranty and liability

Warranty and liability claims for personal injury and property damage are excluded in the case of:

- Improper use of the device.
- Incorrect mounting, commissioning, operation and maintenance of the device.
- Failure to observe the instructions in this operating manual regarding transport, commissioning, operation and maintenance of the device.
- Unauthorised changes to the device made by parties other than the manufacturer.
- Non-observance of technical data.
- Repairs carried out incorrectly.
- The use of accessories or spare parts that are not provided, approved or recommended by the manufacturer.
- Catastrophes caused by external influences and force majeure.
- Mounting and installation with device combinations not approved or recommended by the manufacturer.

This operating manual and the enclosed safety instructions must be observed by all persons working with the device. Furthermore, the rules and regulations that apply for accident prevention at the place of use must be observed.

## 1.9 Disposal of Bender devices

Abide by the national regulations and laws governing the disposal of this device.



For more information on the disposal of Bender devices, refer to [www.bender.de](http://www.bender.de) > service & support.

## 1.10 Safety

If the device is used outside the Federal Republic of Germany, the applicable local standards and regulations must be complied with. In Europe, the European standard EN 50110 applies.



**DANGER** *Risk of fatal injury due to electric shock!*

*Touching live parts of the system carries the risk of:*

- Risk of electrocution due to electric shock
- Damage to the electrical installation
- Destruction of the device

Before installing the device and before working on its connections, make sure that the installation has been de-energised. The rules for working on electrical systems must be observed.

## 2 Function

### 2.1 Intended use

The ISOMETER® monitors the insulation resistance  $R_F$  for DC fast charging stations according to CHAdeMO standard or according to Combined Charging System (CCS) for nominal system voltage ranges between DC 0 V and 400 V.

In order to meet the requirements of the applicable standards, customised parameter settings must be made on the equipment in order to adapt it to local equipment and operating conditions. Please heed the limits of the range of application indicated in the technical data.

Any other use or a use that goes beyond this constitutes improper use.

**i** *To ensure that the ISOMETER® functions correctly, an internal resistance of  $\leq 1 \text{ k}\Omega$  must exist between L+ and L- via the source (e.g. the transformer) or the load.*

**i** *If the ISOMETER® is installed inside a control cabinet, the insulation fault message must be audible and/or visible to attract attention.*

### 2.2 Device features

- Monitoring of the insulation resistance  $R_F$  of DC charging stations in accordance with the CHAdeMO standard or Combined Charging System (CCS)
- CHAdeMO (Mode CHd):
  - Maximum system leakage capacitance  $1.6 \mu\text{F}$  per conductor
  - Detection of insulation faults in the system voltage range from 50 V to 400 V
  - Response time for one-pole insulation faults  $R_{FU}$ :
    - $R_{FU} \leq 100 \text{ k}\Omega$ : max. 1 s
    - $100 \text{ k}\Omega < R_{FU} \leq 2 \text{ M}\Omega$ : max. 10 s
  - Response time for two-pole insulation faults  $R_{FS}$ : max. 10 s
- CCS (Mode dc):
  - Detection of insulation faults up to  $2 \text{ M}\Omega$
  - Maximum system leakage capacitance  $C_e$ :  $5 \mu\text{F}$
  - Response time  $t_{an}$  at  $C_e \leq 5 \mu\text{F}$  or  $R_F \leq 100 \text{ k}\Omega$ : max. 10 s
- Measuring the system leakage capacitance  $C_e$
- Measuring the nominal system voltage  $U_n$  (True-RMS) with undervoltage/overvoltage detection
- Measuring the residual voltages  $U_{L1e}$  (between L+ and earth) and  $U_{L2e}$  (between L- and earth)
- Selectable start-up delay, response delay and delay on release
- Two separately adjustable response value ranges from 5...250 k $\Omega$  (prewarning, alarm)
- Alarm output via LEDs ('AL1', 'AL2'), display, and alarm relays ('K1', 'K2')
- Automatic device self test with connection monitoring
- Selectable N/C or N/O relay operation
- Measured value indication via multi-functional LC display
- Activatable fault memory
- RS-485 (galvanically isolated) including the following protocols:



- BMS (Bender measuring device interface) for the data exchange with other Bender devices
  - Modbus RTU
  - IsoData (for continuous data output)
- Password protection against unauthorised changing of parameters
  - Stop mode to disable the measuring pulse generator

## 2.3 Functional description

The ISOMETER® is designed for use in DC charging stations according to CHAdeMo standard or Combined Charging System (CCS) and can be set to the respective mode in the 'SET' menu via the Mode parameter.

It measures

- the total insulation resistance  $R_{FS}$ ;
- the one-sided insulation resistance  $R_{FU}$ ;
- the system leakage capacitance  $C_e$ ;
- the system voltage  $U_n$  (True RMS) between L+ and L–
- the DC system voltages (residual voltages)  $U_{L1e}$  and  $U_{L2e}$  between L+ as well as L– and earth.

$R_{FS}$  and  $R_{FU}$  are combined to the value  $R_F$ . For  $R_F$  a prewarning and an alarm limit value can be set in the 'AL' menu. The prewarning limit value can only be set higher than the alarm limit value. If the measured value reaches or falls below the limit values, an alarm is signalled. For the measured value  $U_n$  an overvoltage and undervoltage limit value can be enabled and adjusted, the violation of which triggers an alarm. The limit value alarms are deleted when the respective measured value no longer violates the limit value including the corresponding hysteresis.

All alarms generated by the ISOMETER® are signalled via the LEDs 'AL1' and 'AL2'. In the 'out' menu, the alarms can be assigned to the alarm relays ('K1', 'K2'). In addition, the operation of the alarm relays (n.o./n.c.) can be configured and the fault memory 'M' can be activated or deactivated. If the fault memory is activated, the alarm relays remain in alarm condition until the reset button 'R' is pressed or the supply voltage  $U_s$  is interrupted.

In the 't' menu, the start-up delay at device start, the response delay and the delay on message release as well as the repetition time of the automatic device self test can be set.

For the RS-485 interface, the protocols BMS, Modbus RTU or isoData are selected in the 'out' menu. The measured values can be read and the parameters of the ISOMETER® can be set via the BMS protocols, e.g. using the BMS Ethernet gateway (COM465IP) and Modbus RTU. If the isoData protocol is selected, the ISOMETER® only sends the measured values, once per second.

The device function can be tested using the test button 'T'.

The device parameters are set via the LC display and via the control buttons on the front panel. This function can be password-protected.

The ISOMETER® can be set to stop mode to deactivate the measuring pulse generator.

### 2.3.1 $R_F$ and $C_e$ in 'CHd' mode (CHAdeMO)

The insulation fault  $R_F$  and the system leakage capacitance  $C_e$  are only determined for DC system voltages  $\geq 50$  V. The maximum permissible system leakage capacitance  $C_e$  is 1.6  $\mu$ F per conductor. In mode 'CHd' the value  $R_F$  is determined by the smaller of the values  $R_{FU}$  and  $R_{FS}$ .  $R_{FU}$  is the one-pole total insulation fault determined from the voltages  $U_{L1e}$  and  $U_{L2e}$  up to a maximum of 2 M $\Omega$ .

$R_{FS}$  is the two-pole total insulation fault. It is determined up to a maximum of 2 M $\Omega$ .

The response time of the one-pole insulation fault  $R_{FU}$  is one second for  $R_{FU} \leq 100$  k $\Omega$  and  $U_n \geq 50$  V. For values  $R_{FU} > 100$  k $\Omega$  as well as  $R_{FS}$ , the response time of  $R_F$  is  $\leq 10$  s.

### 2.3.2 $R_F$ and $C_e$ in 'dc' mode (CCS)

The insulation fault  $R_F$  up to 2 M $\Omega$  and the system leakage capacitance  $C_e$  are determined independently of the system voltage. The maximum permissible system leakage capacitance is 5  $\mu$ F. The response time for  $R_F$  is 10 s.

### 2.3.3 Fault location R%

From  $U_n > DC 20$  V the fault location R% is calculated for insulation faults  $R_F$  up to 500 k $\Omega$  ('CHd' mode 150 k $\Omega$ ).

#### Value Meaning

- 100 % one-pole insulation fault at L-
- 0 % symmetrical insulation fault
- +100 % one-pole insulation fault at L+

For values of 30 % and more, the alarm assignment of the relays distinguishes between insulation faults at L+ and L-.

From the values R% and  $R_F$  the partial resistances  $R_{F+}$  and  $R_{F-}$  can be calculated using the following formulas:

- Fault at conductor DC+:  $R_{F+} = (200 \% \times R_F) / (100 \% + R\%)$
- Fault at conductor DC-:  $R_{F-} = (200 \% \times R_F) / (100 \% - R\%)$

### 2.3.4 System leakage capacitance $C_e$

The system leakage capacitance  $C_e$  is determined for insulation faults  $R_F > 10$  k $\Omega$  up to a value of 17  $\mu$ F. Above 12  $\mu$ F, the message 'Device error 'E.07'' is displayed.

For applications according to UL 2231-1/-2, the system leakage capacitance  $C_e$  is limited to 5  $\mu$ F.

### 2.3.5 System voltages $U_n$ , $U_{L1e}$ and $U_{L2e}$

The system voltage  $U_n$  between terminals L+ and L- is measured as RMS value (True-RMS). Limit values for overvoltage and undervoltage are available in the 'AL' menu (see 'Setting the response values (AL)'). Above 510 V, the message 'Overvoltage' is displayed regardless of the set overvoltage limit value.

The DC system voltages  $U_{L1e}$  and  $U_{L2e}$  are respectively measured between terminals L+ as well as L- and earth. No limit value is assigned to them.

### 2.3.6 Functional tests of contactors in the charging station and the vehicle

If the ISOMETER® is disconnected on one pole from the monitored voltage source during a functional test of the charging station or vehicle contactors, a false alarm may occur depending on the location of an existing insulation fault. For insulation faults above 250 k $\Omega$  the false alarm can be prevented by a resistor of 200 k $\Omega$  connected directly between the terminals L+ and L-.

### 2.3.7 Monitoring the insulation resistance

The insulation resistance  $R_F$  is monitored by means of the parameters 'R1' (prewarning) and 'R2' (alarm) (see chapter 4.4). The value 'R1' can only be set higher than the value 'R2'. If the insulation resistance  $R_F$  reaches or falls below the activated values 'R1' or 'R2', an alarm message is triggered. If  $R_F$  exceeds the values 'R1' or 'R2' plus the hysteresis value, the alarm will be cleared.

### 2.3.8 Undervoltage/overvoltage monitoring

To monitor the nominal system voltage  $U_n$ , the two parameters 'U <' and 'U >' can be enabled in the response-value menu 'AL' (chapter 4.4). The maximum undervoltage value is limited by the overvoltage value.

The RMS value of the nominal system voltage  $U_n$  is monitored. If the nominal system voltage  $U_n$  reaches, falls below, or exceeds the limit values 'U <' and 'U >', an alarm will be signalled. If the maximum permissible nominal system voltage  $U_n$  set for the ISOMETER® is exceeded, an alarm message will be triggered even if the overvoltage limit value has been deactivated. The alarm will be deleted when the limit values plus hysteresis (chapter 4.4.2) are no longer violated.

### 2.3.9 Stop mode

For applications where the ISOMETER® is not needed and the measuring pulse interferes with other measuring functions, it can be set to stop mode via the Modbus protocol or by pressing and holding the external test/reset button ('T/R'). The measuring pulse generator is turned off and the measuring function is deactivated. The message 'StP' appears on the display. It sends the identifiers 'warning' and 'external test' via the communication interface.

The L+ and L- connections disconnect from the monitored mains. The electronic circuit breakers are in the device.

### 2.3.10 Self test functions (device errors)

During the normal measuring function the ISOMETER® checks its correct function in the background.

Other tests interrupt the the measuring function of the device. The user can trigger these as follows:

- cyclically via a timer (menu item 't' / 'test') or
- via the internal or external test button or
- via the communication interface (COM)

In case of a device error, all LEDs flash, the display shows the message 'E.xx' according to the error code table and, depending on the message assignment, the relays switch.

#### Cyclic background test

The cyclic background test checks the functionality of the  $\mu$ C. It is not visible to the user and does not influence the measuring function. In case of malfunction, the respective device error messages 'E.09' to 'E.16' appear.

#### Continuous PE connection monitoring

The connection of terminal 'E' to the PE protective conductor is monitored continuously and in parallel with the measuring function of the device via the input 'KE', which is also connected to the PE protective conductor. When the connection is interrupted, the device error message 'E.01' appears.

## User-controlled test functions

The user-controlled test functions interrupt the measuring function of the device. They always include a test of the measurement technology (error code 'E.05') and additionally a test of the connection between the terminals L+ and L- via the system to be monitored (error code 'E.02') which can be activated by the user (menu 'SEt' / 'nEt').

If these test functions are started via a test button or the communication interface, this can be indicated not only by the LEDs AL1 and AL2 lighting up but also by the message 'test' via the relays (menu 'out' / 'Signalling assignment').

## Internal and external test button

Pressing the external test/reset button or the test button 'T' on the device (> 1.5 s) starts the user-controlled test functions. Holding the test button 'T' on the device also shows all available display elements.

## Timer for test functions

At menu item 't'/'test' the user-controlled test can be activated in a cycle of one or 24 hours. The timer restarts after each completed test, regardless of whether it was triggered by the timer or manually.

## Device test at device start

At menu item 'SEt'/'S.Ct' the user-controlled test functions can be activated for device start.

## System connection test

The system connection test configurable in the menu 'SEt'/'nEt' checks the connection between the terminals L+ and L- via the monitored system. For the ISOMETER® to function correctly, the monitored system must have a low internal resistance  $R_i < 1 \text{ k}\Omega$ .

If an error is detected, the message Device error system connection 'E.02' appears. If the System voltage  $U_n$  is below DC -30 V during the mains connection test, the message Device error polarity reversal 'E.03' also appears.

## Error codes

In the event of a device error, **error codes** are shown in the display. Some of these are described below:

Overview of some error codes

Error code	Meaning
E.01	<p><b>PE connection error</b> The connection of 'E' or 'KE' to earth is interrupted. <b>Action:</b> Check connection, eliminate error. The error code will be erased automatically once the error has been eliminated.</p>
E.02	<p><b>System connection error</b> The internal resistance of the system is too high or the connection of 'L+' or 'L-' to the system is interrupted. The terminals 'L+' and 'L-' are connected incorrectly. <b>Action:</b> Check connection, eliminate error. The error code will be erased automatically once the error has been eliminated.</p>
E.03	<p><b>Reversed polarity connection error</b> Terminals 'L+' and 'L-' are connected to the DC system to be monitored with reversed polarity. Detection from <math>U_n &lt; \text{DC } -30 \text{ V}</math></p>

Error code	Meaning
E.05	<p><b>Measurement error</b> Due to system interferences or a device error, the insulation measured value is no longer updated. Prewarning and alarm are set for the insulation measured value at the same time.</p> <p><b>Calibration invalid after software update</b> 'E.05' appears together with 'E.08': The software is not compatible to the calibration of the device. <b>Action:</b> Install the previous software version or have the device calibrated at the factory.</p>
E.07	<p><b>Permissible system leakage capacitance <math>C_g</math> exceeded</b> The device is not suitable for the present network leakage capacitance <math>C_g</math>. <b>Action:</b> Uninstall the device.</p>
E.08	<p><b>Calibration error</b> <b>Action:</b> Check connection, eliminate error. If the error is still present, there is a device error.</p>

Internal device errors 'E.xx' can be caused by external disturbances or internal hardware errors. If the error message occurs again after the device has been restarted or after a reset to the factory settings (menu item 'FAC'), the device must be repaired. After the fault has been eliminated, the alarm relays switch back either automatically or when the reset button is pressed. The self test can take a few minutes.

### 2.3.11 Alarm assignment of the alarm relays K1/K2

The notifications for 'device error', 'insulation fault', 'undervoltage/overvoltage fault', 'device test' and 'device start with alarm' can be assigned to the alarm relays via the 'out' menu.

An **insulation fault** is indicated by these messages:

- '+R1' and '+R2': insulation fault assigned to conductor L+
- '-R1' and '-R2': insulation fault assigned to conductor L-

If an assignment to a conductor is not possible, e.g. due to a symmetrical insulation fault, the respective '+' and '-' messages are set together.

The message 'test' indicates a **device test** triggered manually via a test button or the communication interface.

The message 'S.AL' indicates a **device start with alarm**. When the parameter value is set to 'S.AL = on' and the supply voltage  $U_s$  is connected, the ISOMETER® starts with the insulation measured value  $R_F = 0 \Omega$  and sets all activated alarms. The alarms will be cleared only when the measured values are up-to-date and no thresholds are violated. In the factory setting 'S.AL = off', the ISOMETER® starts without an alarm.



**Recommendation:** Set parameter value 'S.AL' identical for both relays.

### 2.3.12 Fault memory

#### Disabled (OFF)

The LEDs and relays signal the fault as long as it is detected.

#### Enabled (ON)

The LEDs and relays signal the fault until a reset is performed or the supply voltage  $U_s$  is disconnected.

### 2.3.13 Digital interfaces

The ISOMETER® uses the serial hardware interface RS-485 with the following protocols:

- **BMS**

The BMS protocol is an essential component of the Bender measuring device interface (BMS bus protocol). Data transmission generally makes use of ASCII characters.

- **Modbus RTU**

Modbus RTU is an application layer messaging protocol, and it provides master/slave communication between devices that are connected via bus systems and networks. Modbus RTU messages have a 16-bit CRC (cyclic redundant checksum), which guarantees reliability.

- **IsoData**

The ISOMETER® sends an ASCII data string with a cycle of approximately 1 second. Communication with the ISOMETER® in this mode is not possible, and no additional sender may be connected via the RS-485 bus cable. The ASCII data string for the ISOMETER® is described in chapter 5.4.



*The IsoData protocol can be terminated by sending the command 'Adr3' during a transmission pause of the ISOMETER®.*

The parameter address, baud rate and parity for the interface protocols are configured in the 'out' menu.



*With 'Adr = 0', the menu entries baud rate and parity are not shown in the menu and the IsoData protocol is activated.*

*With a valid bus address (i.e. not equal to 0), the menu item 'baud rate' is displayed in the menu. The parameter value '---' for the baud rate indicates the activated BMS protocol. In this case, the baud rate for the BMS protocol is set to 9600 baud. If the baud rate is set unequal to '---', the Modbus protocol with configurable baud rate is activated.*

### 2.3.14 Measuring and response times

#### Operating time $t_{ae}$

The operating time  $t_{ae}$  is the time required by the ISOMETER® to determine the measured value. For the insulation measured value  $R_F$ , the system leakage capacitance  $C_e$ , the residual voltages  $U_{L1e}$  and  $U_{L2e}$  as well as for the faulty conductor 'R%' it depends on the insulation resistance  $R_F$  and the system leakage capacitance  $C_e$ .



*System disturbances may lead to extended measuring times. The measuring time of the nominal system voltage  $U_n$  is independent of this and significantly shorter.*

#### Response delay $t_{on}$

The response delay  $t_{on}$  is set uniformly for all alarm messages in the 't' menu using the parameter 'ton', while each alarm message specified in the alarm assignment has its own timer for  $t_{on}$ . This delay can be used for interference suppression in the case of short measuring times.

An alarm message will only be signalled when a limit value of the respective measured value is violated for the duration of  $t_{on}$ . Each time the limit value is violated within the time  $t_{on}$ , the response delay 'ton' restarts.

#### Total response time $t_{an}$

The total response time  $t_{an}$  is the sum of the operating time  $t_{ae}$  and the response delay  $t_{on}$ .

#### Delay on release $t_{off}$

The delay on release  $t_{\text{off}}$  can be set uniformly for all alarm messages using the parameter 'toff', while each alarm message specified in the alarm assignment has its own timer for  $t_{\text{off}}$ .

An alarm message will be signalled until the limit value of the respective measured value is no longer violated (including hysteresis) for the duration of  $t_{\text{off}}$  without interruption. Each time a limit value is no longer violated during  $t_{\text{off}}$ , the delay on release 'toff' restarts.

#### **Start-up delay t**

After connecting the supply voltage  $U_S$ , the alarm output is suppressed for the time set in parameter 't' (0...10 s).

### **2.3.15 Password protection (on, OFF)**

If password protection is activated (on), settings can only be made after entering the password (0...999). For its activation, see chapter 4.7.

### **2.3.16 External test/reset button (T/R)**

#### **Functions**

- Reset = press the external button < 1.5 s
- Reset + self test = press the external button > 1.5 s
- Stop measuring function = press and hold the external button



*When the measuring function is stopped, the display shows 'StP'.*

The stop function can also be triggered via an interface command, and in this case it can only be reset via the interface.

Only one ISOMETER® may be controlled via an external test/reset button.

A galvanic parallel connection of several test or reset inputs for testing multiple insulation monitoring devices is not allowed.

### **2.3.17 History memory HiS**

The history memory saves exclusively the measured values for the first fault. The history memory must first be cleared before new measured values can be saved.

The values checked in the table in section 'Displaying measured values' can be saved.

### 3 Installation, connection and commissioning

#### 3.1 Dimensions

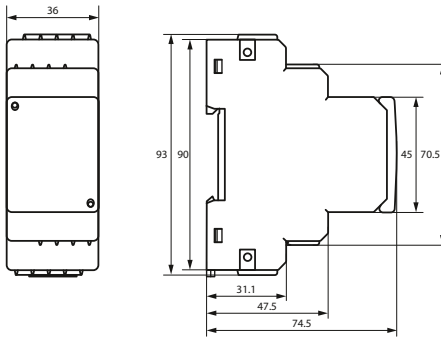

Figure: Dimension diagram (in mm)

#### 3.2 Installation

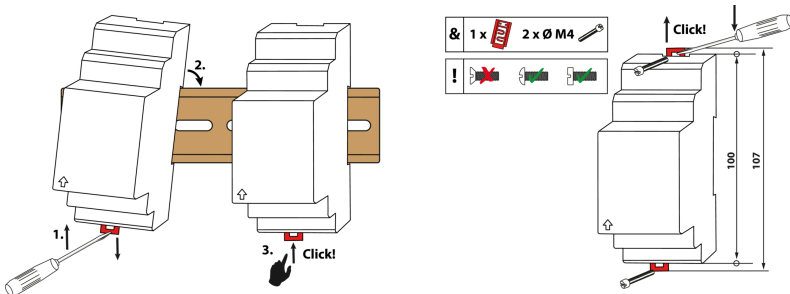

Figure: DIN rail mounting (left) or screw mounting (right)

#### 3.3 Connection



##### **DANGER** *Risk of fatal injury due to electric shock!*

*Touching live parts of the system carries the risk of:*

- Risk of electrocution due to electric shock
- Damage to the electrical installation
- Destruction of the device

Before installing the device and before working on its connections, make sure that the installation has been de-energised. The rules for working on electrical systems must be observed.

For details about the conductor cross sections required for wiring, refer to chapter "6 Technical data".



**Wiring diagram**

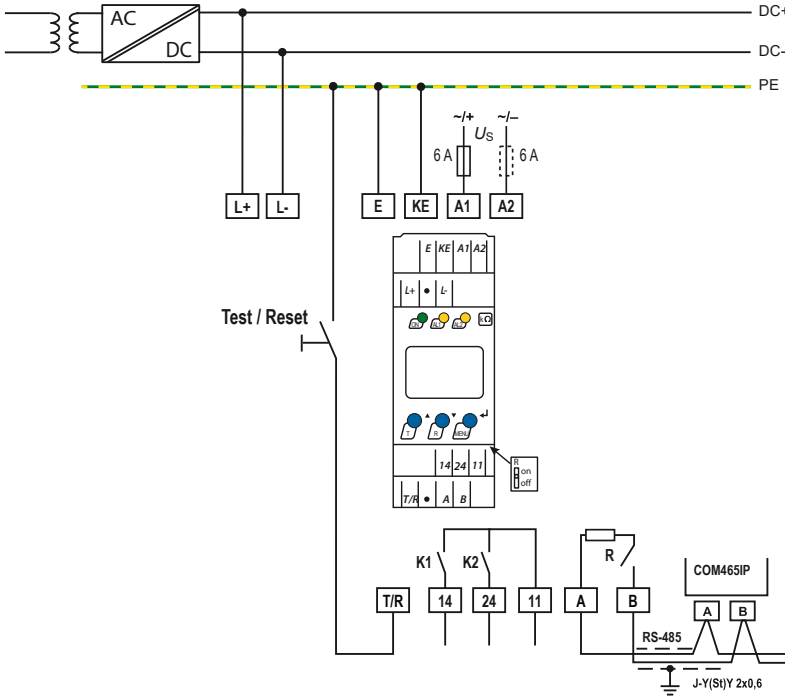

Figure: Wiring diagram

**Legend to wiring diagram**

Terminal	Connections
<b>A1, A2</b>	Connection to the supply voltage $U_s$ via fuse (line protection): If supplied from an IT system, protect both lines by a fuse.*
<b>E, KE</b>	Connect each terminal separately to PE: Use same wire cross section as for 'A1', 'A2'.
<b>L+, L-</b>	Connection to the system to be monitored Indication in display: 'L1' for L+; 'L2' for L-
<b>T/R</b>	Connection for the external combined test and reset button
<b>11, 14</b>	Connection to alarm relay 'K1'
<b>11, 24</b>	Connection to alarm relay 'K2'
<b>A, B</b>	RS-485 communication interface with connectable terminating resistor Example: Connection of a BMS Ethernet gateway COM465IP

- i** \* **For UL applications:**  
 Use 60/70 °C copper lines only!  
 For UL and CSA applications, using 5 A fuses for the protection of the supply voltage  $U_s$  is mandatory.

### 3.4 Commissioning

1. **Check that the ISOMETER® is properly connected to the system to be monitored.**
2. **Connect supply voltage  $U_s$  to the ISOMETER®.**

The start routine can take up to 30 s. Afterwards, the current insulation resistance is shown as the standard display.



The pulse symbol  signals an error-free update of the resistance and capacitance measured values. If the measured value cannot be updated due to disturbances, the pulse symbol will be blanked.

3. **Set the correct insulation monitoring mode** in the 'SEt' menu. The factory setting is 'CHd'.
4. **Start a manual self test** by pressing the test button 'T' > 1.5 s. While holding the test button all available display elements are shown. After releasing the button, the test starts and 'tES' flashes for the duration of the test. Detected malfunctions are displayed as error codes (see chapter 2.3.11).

**i** *The alarm relays are not checked during the test (factory setting). The setting can be changed in the 'out' menu so that the relays switch to the alarm state during the manual self test.*

5. **Check if the settings are suitable for the system being monitored.**

The list of factory settings is shown in the tables from chapter 4.4.

**i** *For networks with a leakage capacitance > 5  $\mu$ F, the response value  $R_{ant}$  should be set to a maximum of 200 k $\Omega$  due to the increased measurement tolerance.*

6. **Check the functionality by a real insulation fault.**

Use a suitable resistor to check the ISOMETER® against earth in the system being monitored.

## 4 Operation



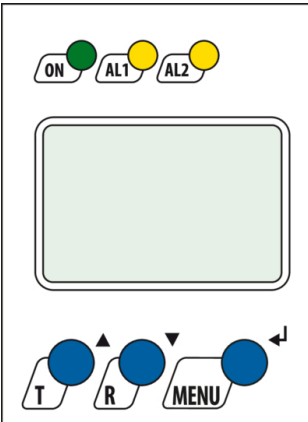



### 4.1 Operating and display elements

Device front	Operating elements	Function
	<b>ON</b>	● Device is running
	<b>AL1</b>	● Prewarning ◎ Overvoltage
	<b>AL2</b>	● Alarm ◎ Undervoltage
	▲▼	Up and down buttons – For navigating up or down in the menu settings. – For increasing or decreasing values.
	<b>T</b>	Test button (press > 1.5 s)
	<b>R</b>	Reset button (press > 1.5 s)
	↵	Enter button – Select menu item. – Save value.
	<b>MENU</b>	MENU button (press > 1.5 s) – Starts menu mode. – Exits menu item without saving changes.

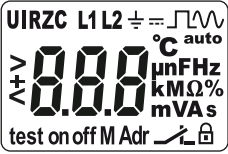
- LED on
- ◎ LED flashes



The 'prewarning' and 'alarm' messages can be assigned to the relays, see chapter 4.5.2.

Display	Display elements	Function
	<b>U</b>	Nominal system voltage $U_n$
	<b>R</b>	Insulation resistance $R_F$
	<b>C</b>	System leakage capacitance $C_e$
	<b>L1 L2</b> 	Monitored conductors L1 = L+ L2 = L-
		Voltage type DC
		Pulse symbol: error-free measured value update
		Voltage type AC
	<b>auto</b>	Automatic self test active
	<b>°C</b> <b>μ n F Hz</b> <b>k M Ω %</b> <b>m V A s</b>	Measured values and units
		Password protection is activated
		In the menu mode, the operating mode of the respective alarm relay is displayed.
	<b>Adr</b>	Communication interface with measured value: isoData operation
	<b>M</b>	Fault memory is activated
	<b>on / off</b>	Condition symbols
	<b>test</b>	Self test is active
<b>&gt;</b> <b>+</b> <b>&lt;</b>	Identification for response values and response value violation	

**i**

The display parameters that can be configured flash.

The readability below  $-25\text{ °C}$  is limited.

Depending on the ISOMETER®'s scope of functions, not all display elements are used.



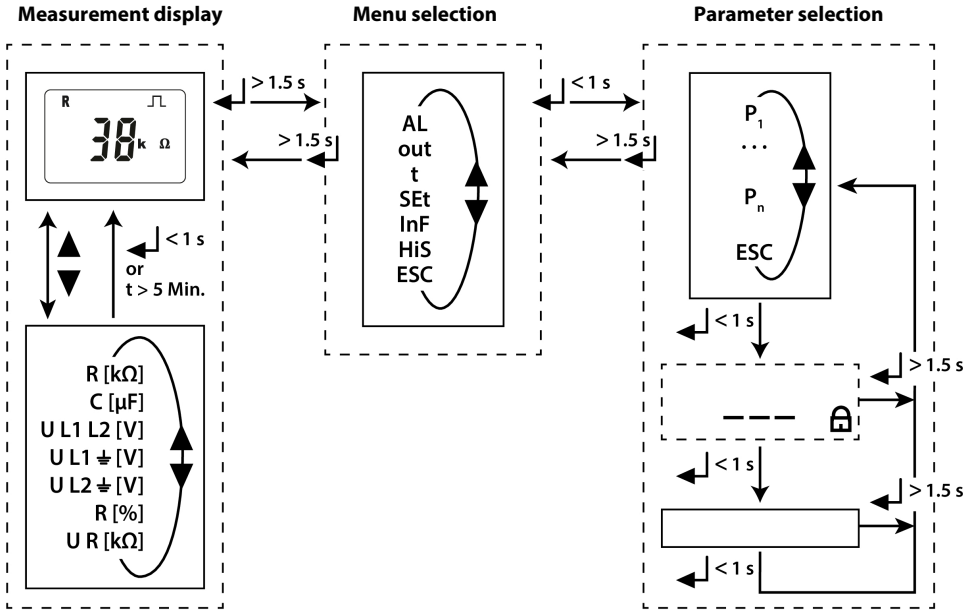

## 4.2 Menu overview



Menu item	Parameter
<b>AL</b>	Querying and setting response values
<b>out</b>	Configuring fault memory, alarm relays and interface
<b>t</b>	Setting delay times and self test cycles
<b>SEt</b>	Setting device control parameters
<b>InF</b>	Querying software version
<b>HiS</b>	Querying and clearing the history memory
<b>ESC</b>	Going to the next-higher menu level

### 4.3 Displaying measured values

#### Overview

HiS	Display	Description	
✓	$\pm R \text{ k}\Omega$ 	<b>Insulation resistance</b> 1 k $\Omega$ ... 2 M $\Omega$	$R_F^*$ Resolution: 1 k $\Omega$ ; from 1 M $\Omega$ : 0.1 M $\Omega$
		The '+' or '-' sign appears, when an error of $R_F < 100 \text{ k}\Omega$ is mainly detected at L+ or L- with $ R\%  \geq 30 \%$ .	
✓	$C \text{ }\mu\text{F}$ 	<b>System leakage capacitance</b> 0 ... 17 $\mu\text{F}$	$C_e$ Resolution: 1 nF
✓	$\sim \pm U \text{ L1 L2} = \text{V}$	<b>Nominal system voltage L+ - L-</b> 0 $V_{\text{trueRMS}}$ ... 500 $V_{\text{trueRMS}}$	$U_n^*$ Resolution: 1 $V_{\text{trueRMS}}$
		When $U_{\text{RMS}} > 20 \text{ V}$ , the '+' or '-' sign indicates the polarity at terminals 'L+' and 'L-'. The sign '~' indicates an AC system.	
✓	$\pm U \text{ L1}$  = V	<b>Residual voltage L+ - PE</b> DC 0 $\pm 500 \text{ V}$	$U_{\text{L1e}}$ Resolution: 1 V
✓	$\pm U \text{ L2}$  = V	<b>Residual voltage L- - PE</b> DC 0 $\pm 500 \text{ V}$	$U_{\text{L2e}}$ Resolution: 1 V
-	$\pm R \%$	<b>Fault location in %</b> -100 % ... +100 % Indicated if $U_n \geq \text{DC } 20 \text{ V}$ and $R_F \leq 500 \text{ k}\Omega$	
✓	$U \text{ R} = \text{k}\Omega$ 	<b>One-side insulation resistance</b> 1 k $\Omega$ ... 2 M $\Omega$	$R_{\text{FU}}$ Resolution: 1 k $\Omega$ ; from 1 M $\Omega$ : 0.1 M $\Omega$
		calculated from $U_{\text{L1e}}$ and $U_{\text{L2e}}$ if $U_n > \text{DC } 40 \text{ V}$	

✓ The measured value can be displayed in the history memory.

\* The measured value can be configured as standard display.

#### Displaying the current measured values

The standard display shows the currently measured value for  $R_F$  or  $U_n$ . Press the up or down buttons to display the other measured values. After 5 min at the latest the display switches back to the standard display.



#### ADVICE

The pulse symbol indicates a currently measured value. If this symbol does not appear, the measurement is still ongoing and the latest valid measured value will be displayed. The symbols '<' or '>' will be displayed additionally to the measured value when a response value has been reached or violated, or the measured value is below or above the measuring range.

## Changing the standard display

$R_F$  or  $U_n$  can be set as standard display:

1. From the standard display, navigate to the desired display with the up or down button.
2. Confirm with Enter.

## 4.4 Setting the response values (AL)

### 4.4.1 Response values overview

Display	Activation		Setting value			Description
	FAC	Cs	Range	FAC	Cs	
R1 <	<b>on</b>	not configurable	R2 ... 250	<b>230</b>	kΩ	Prewarning value $R_{an1}$ Hys. = 25 % / min. 1 kΩ
R2 <	<b>on</b>	not configurable	5 ... R1	<b>48</b>	kΩ	Alarm value $R_{an2}$ Hys. = 25 % / min. 1 kΩ
U <	<b>off</b>		10 ... U >	<b>10</b>	V	Alarm value undervoltage Hys. = 5 % / min. 5 V
U >	<b>off</b>		U < ... 500	<b>500</b>	V	Alarm value overvoltage Hys. = 5 % / min. 5 V

FAC Factory settings

Cs Customer settings

### 4.4.2 Setting the insulation resistance parameters

#### How to proceed

1. Open menu 'AL'.
2. Select parameter 'R1' for prewarning or parameter 'R2' for alarm.
3. Set value and confirm with Enter.

### 4.4.3 Setting parameters for undervoltage and overvoltage



#### How to proceed

1. Open menu 'AL'.
2. Select parameter 'U <' for undervoltage or parameter 'U >' for overvoltage.
3. Set value and confirm with Enter.

## 4.5 Configuring fault memory, alarm relays, and interfaces (out)

Call up menu 'out' to configure fault memory, alarm relays, and interfaces.

### 4.5.1 Configuring the relays

Relay K1			Relay K2			Description
Display	FAC	Cs	Display	FAC	Cs	
 1	n.c.		 2	n.c.		Operating mode of the relay n.c./n.o.



























FAC Factory settings

Cs Customer settings

### 4.5.2 Assigning the alarm messages to the relays

The 'on' setting assigns an alarm message to the respective relay. The LED indication is directly assigned to the alarm message and is not related to the relays.

In the event of an unsymmetrical insulation fault, only the alarm message corresponding to the assigned conductor (L+ or L-) will be displayed.

K1 'r1'			K2 'r2'			LEDs			Description
Display	FAC	Cs	Display	FAC	Cs	ON	AL1	AL2	
 1 Err	off		 2 Err	on					Device error E.xx
r1 +R1 < $\Omega$	on		r2 +R1 < $\Omega$	off					Prewarning R1 Fault $R_f$ at L1/+
r1 -R1 < $\Omega$	on		r2 -R1 < $\Omega$	off					Prewarning R1 Fault $R_f$ at L2/-
r1 +R2 < $\Omega$	off		r2 +R2 < $\Omega$	on					Alarm R2 Fault $R_f$ at L1/+
r1 -R2 < $\Omega$	off		r2 -R2 < $\Omega$	on					Alarm R2 Fault $R_f$ at L2/-
r1 U < V	off		r2 U < V	on					Alarm $U_n$ Undervoltage
r1 U > V	off		r2 U > V	on					Alarm $U_n$ Overvoltage
r1 test	off		r2 test	off					Manually started device test



K1 'r1'			K2 'r2'			LEDs			Description
Display	FAC	Cs	Display	FAC	Cs	ON	AL1	AL2	
r1 S.AL	<b>off</b>		r2 S.AL	<b>off</b>		●	●	●	Device start with alarm

- FAC Factory settings  
 Cs Customer settings  
 ○ LED off  
 ⊙ LED flashes  
 ● LED on

### 4.5.3 Activating or deactivating fault memory

Display	FAC	Cs	Description
M	<b>off</b>		Memory function for alarm messages (fault memory)

- FAC Factory settings  
 Cs Customer settings

### 4.5.4 Configuring interface

Display	Setting value				Description
	Range	FAC	Cs		
Adr	0/3...90	<b>3</b>	( )	Bus Adr.	Adr = 0 deactivates BMS as well as Modbus and activates isoData with continuous data output (115k2, 8E1)
Adr 1	---/ 1.2k...115k	<b>19.2k</b>	( )	Baud rate	'---': BMS bus (9k6, 7E1) '1.2k' ... '115k': Modbus (variable)
Adr 2	8E1 8o1 8n1 8n2	<b>8E1</b>	( )	Modbus	<b>8E1</b> - 8 data bits, even parity, 1 stop bit <b>8o1</b> - 8 data bits, odd parity, 1 stop bit <b>8n1</b> - 8 data bits, no parity, 1 stop bit <b>8n2</b> - 8 data bits, no parity, 2 stop bits

- FAC Factory settings  
 Cs Customer settings  
 ( ) Customer setting that is not modified by FAC.

**i** Adr 2 can only be selected, if Adr 1 is not '---'.

## 4.6 Setting delay times and self test cycles (t)

Open menu 't' to configure the times.

Display	Setting value			Description
	Range	FAC	Cs	
t	0...10	0	s	Start-up delay when starting the device
ton	0...99	0	s	Response delay K1 and K2
toff	0...99	0	s	Delay on release K1 and K2
test	OFF/1/24	OFF	h	Repetition time for device test

FAC Factory settings

Cs Customer settings



To comply with the standard UL 2231, the parameter 'test' must be 'OFF'.

## 4.7 Setting device control parameters (SEt)

Open menu 'SEt' to configure the device control.

Display	Activation		Setting value			Description
	FAC	Cs	Range	FAC	Cs	
	off		0...999	0		Password for parameter setting
dc CHd			dc CHd	<b>CHd</b>		Insulation monitoring mode <b>dc:</b> CCS $t_{an} \leq 10$ s <b>CHd:</b> CHAdeMO Values $R_{FU}$ , $R_{FS}$ and $C_e$ if $U_n > DC 50$ V $t_{an} \leq 1$ s if $R_{FU} \leq 100$ k $\Omega$ $t_{an} \leq 10$ s if $R_{FU} > 100$ k $\Omega$ and $R_{FS}$
nEt	on					System connection test
S.Ct	off					Device test at device start
FAC						Restore factory settings
SYS						For Bender Service only

FAC Factory settings

Cs Customer settings

## 4.8 Reset to factory settings

All settings with the exception of the interface parameters are reset to the factory settings.

1. Press MENU button (> 1.5 s).
2. Go to 'SEt' and confirm with Enter.
3. Go to 'FAC' and confirm with Enter.

## 4.9 Showing and deleting the history memory



### ADVICE

The history memory saves the measured values for the first fault only. To this end, the history memory must be empty.

### Show history memory

Call up 'HiS' menu and go up or down.

### Delete history memory

Call up 'HiS' menu, go to 'Clr' and confirm.

## 4.10 Querying software version (InF)

The software version is displayed as a ticker. Afterwards it can be output step by step using the up or down buttons.

### How to proceed

1. Press MENU button (> 1.5 s).
2. Go to 'InF' and confirm with Enter.
3. If necessary, use up or down buttons to display it step by step.

## 5 Data access via RS-485 interface

### 5.1 Data access using the BMS protocol

The BMS protocol is an essential component of the Bender measuring device interface (BMS bus protocol). Data transmission generally makes use of ASCII characters.

BMS channel no.	Operation value	Alarm
1	$R_F$	Prewarning R1
2	$R_F$	Alarm R2
3		
4	$U_n$	Undervoltage
5	$U_n$	Overvoltage
6		Connection fault, earth (E.01)
7		Connection fault, system (E.02)
8		All other device errors (E.xx)
9	Fault location [%]	
10	$C_e$	
11		
12	Update counter	
13	$U_{L1e}$	
14	$U_{L2e}$	
15	$R_{FU}$	

### 5.2 Data access using the Modbus RTU protocol

Requests to the ISOMETER® can be made using the function code 0x03 (read multiple registers) or the command 0x10 (write multiple registers). The ISOMETER® generates a function-related answer and sends it back.

#### 5.2.1 Reading out the Modbus register from the ISOMETER®

The required Words of the process image can be read out from the ISOMETER® 'Holding Registers' using function code 0x03. For this purpose, the start address and the number of the registers to be read out must be entered. Up to 125 Words (0x7D) can be read out with one single request.

### Command of the master to the ISOMETER®

In the following example, the master of the ISOMETER® requests the content of register 1003 using address 3. The register contains the channel description of measuring channel 1.

Byte	Name	Example
Byte 0	ISOMETER® Modbus address	0x03
Byte 1	Function code	0x03
Byte 2, 3	Start address	0x03EB
Byte 4, 5	Number of registers	0x0001
Byte 6, 7	CRC16 checksum	0xF598

### Answer of the ISOMETER® to the master

Byte	Name	Example
Byte 0	ISOMETER® Modbus address	0x03
Byte 1	Function code	0x03
Byte 2	Number of data bytes	0x02
Byte 3, 4	Data	0x0047
Byte 7, 8	CRC16 checksum	0x81B6

## 5.2.2 Writing the Modbus register (parameter setting)

Registers in the device can be modified with function code 0x10 (set multiple registers). Parameter registers start with address 3000. For the contents of the registers, see table in chapter 5.3.2.1.

### The master sends a command to the ISOMETER®

In this example, address 3 is used to set the content of register address 3003 to 2.

Byte	Name	Example
Byte 0	ISOMETER® Modbus address	0x03
Byte 1	Function code	0x10
Byte 2, 3	Start register	0x0BBB
Byte 4, 5	Number of registers	0x0001
Byte 6	Number of data bytes	0x02
Byte 7, 8	Data	0x0002
Byte 9, 10	CRC16 checksum	0x9F7A

### Response of the ISOMETER® to the master

Byte	Name	Example
Byte 0	ISOMETER® Modbus address	0x03
Byte 1	Function code	0x10
Byte 2, 3	Start register	0x0BBB
Byte 4, 5	Number of registers	0x0001
Byte 6, 7	CRC16 checksum	0x722A

### 5.2.3 Exception code

If the ISOMETER® cannot respond to a request, it will send an exception code with which possible faults can be narrowed down.

Exception code	Description
0x01	Impermissible function
0x02	Impermissible data access
0x03	Impermissible data value
0x04	Internal fault
0x05	Acknowledgement of receipt (answer will be time-delayed)
0x06	Request not accepted (repeat request if necessary)

### Structure of the exception code

Byte	Name	Example
Byte 0	ISOMETER® Modbus address	0x03
Byte 1	Function code (0x03) + 0x80	0x83
Byte 2	Data (exception code)	0x04
Byte 3, 4	CRC16 checksum	0xE133

## 5.3 Modbus register assignment

### 5.3.1 Modbus measured value registers

Depending on the device condition, the information in the registers is the measured value without alarm, the measured value with alarm 1, the measured value with alarm 2, or the device error. For more information see , page 32.

Register	Measured value			Device error
	Without alarm	Alarm 1 (prewarning)	Alarm 2 (alarm)	
1000...1003	$R_F$ Insulation fault (71)	$R_F$ Insulation fault (1)	$R_F$ Insulation fault (1)	Earth connection (102)
1004...1007				
1008...1011	$U_n$ Voltage (76)	$U_n$ Overvoltage (78)	$U_n$ Undervoltage (77)	Connection to system (101)
1012...1015	$C_e$ Capacitance (82)			
1016...1019	$U_{L1e}$ Voltage (76)			
1020...1023	$U_{L2e}$ Voltage (76)			
1024...1027	Fault location in % (1022)			
1028...1031	$R_{FU}$ Insulation fault (71)			
1032...1035	Measured value update counter (1022)			Device error (115)

( ) channel description code (see ")

#### 5.3.1.1 Measurement coding

Each measured value is available as a channel and consists of 8 bytes (4 registers). The first measured value register address is 1000. The structure of a channel is always the same. Content and number depend on the device. The structure of a channel is shown with the example of channel 1:

1000		1001		1002		1003	
HiByte	LoByte	HiByte	LoByte	HiByte	LoByte	HiByte	LoByte
Floating point value (Float)				Alarm type and test type (AT&T)	Range and unit (R&U)	Channel description	

### 5.3.1.2 Float = Floating point value of the channels

Representation of the bit order for processing analogue measured values according to IEEE 754

Word	0x00																0x01															
Byte	HiByte								LoByte								HiByte								LoByte							
Bit	31	30	29	28	27	26	25	24	23	22	21	20	19	18	17	16	15	14	13	12	11	10	9	8	7	6	5	4	3	2	1	0
	S	E	E	E	E	E	E	E	E	M	M	M	M	M	M	M	M	M	M	M	M	M	M	M	M	M	M	M	M	M	M	M

E exponent

M mantissa

S sign

### 5.3.1.3 AT&T = Alarm type and test type (internal/external)

Bit	7	6	5	4	3	2	1	0	Meaning
	Test external	Test internal	Reserved	Reserved	Reserved	Alarm	Fault		
Alarm type	X	X	X	X	X	0	0	0	No alarm
	X	X	X	X	X	0	0	1	Prewarning
	0	0	X	X	X	0	1	0	Device error
	X	X	X	X	X	0	1	1	Reserved
	X	X	X	X	X	1	0	0	Warning
	X	X	X	X	X	1	0	1	Alarm
	X	X	X	X	X	1	1	0	Reserved
	X	X	X	X	X	1	1	1	Reserved
Test	0	0	X	X	X	X	X	X	No test
	0	1	X	X	X	X	X	X	Internal test
	1	0	X	X	X	X	X	X	External test

- Bits 0 to 2: coding for the alarm type
- Bits 3 to 5: reserved; value 0
- Bit 6 oder 7: set when an internal or external test has been completed

Other values are reserved. The complete byte is calculated from the sum of the alarm type and the test type.



**5.3.1.4 R&U = Range and unit**

Bit	7	6	5	4	3	2	1	0	Meaning
Unit	-	-	-	0	0	0	0	0	Invalid (init)
	-	-	-	0	0	0	0	1	No unit
	-	-	-	0	0	0	1	0	Ω
	-	-	-	0	0	0	1	1	A
	-	-	-	0	0	1	0	0	V
	-	-	-	0	0	1	0	1	%
	-	-	-	0	0	1	1	0	Hz
	-	-	-	0	0	1	1	1	Baud
	-	-	-	0	1	0	0	0	F
	-	-	-	0	1	0	0	1	H
	-	-	-	0	1	0	1	0	°C
	-	-	-	0	1	0	1	1	°F
	-	-	-	0	1	1	0	0	Second
	-	-	-	0	1	1	0	1	Minute
	-	-	-	0	1	1	1	0	Hour
	-	-	-	0	1	1	1	1	Day
-	-	-	1	0	0	0	0	Month	
Range of validity	0	0	X	X	X	X	X	X	Actual value
	0	1	X	X	X	X	X	X	The actual value is lower
	1	0	X	X	X	X	X	X	The actual value is higher
	1	1	X	X	X	X	X	X	Invalid value

- Bits 0 to 4: coding for the unit
- Bits 6 and 7: validity range of a value
- Bit 5: reserved

The complete byte is calculated from the sum of the unit and the range of validity.

### 5.3.1.5 Channel descriptions

Value	Description of measured value / message	Comments
0		
1 (0x01)	Insulation fault	
71 (0x47)	Insulation fault	Insulation resistance $R_F$ in $\Omega$
76 (0x4C)	Voltage	Measured value in V
77 (0x4D)	Undervoltage	
78 (0x4E)	Overvoltage	
82 (0x52)	Capacitance	Measured value in F
86 (0x56)	Insulation fault	Impedance $Z_i$
101 (0x65)	System connection	
102 (0x66)	Earth connection	
115 (0x73)	Device error	ISOMETER® fault
129 (0x81)	Device error	
145 (0x91)	Own address	

## 5.3.2 Modbus parameter register

### 5.3.2.1 Parameter coding

Register	Property	Description	Format	Unit	Value range
999	RO	Number of Modbus measured-value channels with active alarm	UINT 16		0...9
3000	RW	Reserved			
3001	RW	Reserved			
3002	RW	Reserved			
3003	RW	Reserved			
3004	RW	Reserved			
3005	RW	Prewarning value Resistance measurement 'R1'	UINT 16	k $\Omega$	R2 ... 250
3006	RW	Reserved			
3007	RW	Alarm value resistance measurement 'R2'	UINT 16	k $\Omega$	5 ... R1
3008	RW	Activation alarm value undervoltage 'U <'	UINT 16		0 = off 1 = on
3009	RW	Alarm value undervoltage 'U <'	UINT 16	V	10 ... U >

Register	Property	Description	Format	Unit	Value range
3010	RW	Activation alarm value overvoltage 'U >'	UINT 16		0 = off 1 = on
3011	RW	Alarm value overvoltage 'U >'	UINT 16	V	U < ... 500
3012	RW	Memory function for alarm messages (fault memory) 'M'	UINT 16		0 = off 1 = on
3013	RW	Operating mode of relay 1 'r1'	UINT 16		0 = n.o. 1 = n.c.
3014	RW	Operating mode of relay 2 'r2'	UINT 16		0 = n.o. 1 = n.c.
3015	RW	Bus address 'Adr'	UINT 16		0 / 3 ... 90
3016	RW	Baud rate 'Adr 1'	UINT 16		0 = BMS 1 = 1.2 k 2 = 2.4 k 3 = 4.8 k 4 = 9.6 k 5 = 19.2 k 6 = 38.4 k 7 = 57.6 k 8 = 115.2 k
3017	RW	Parity 'Adr 2'	UINT 16		0 = 8N1 1 = 8O1 2 = 8E1 3 = 8N2
3018	RW	Start-up delay 't' during device start	UINT 16	s	0 ... 10
3019	RW	Response delay 'ton' for relays 'K1' and 'K2'	UINT 16	s	0 ... 99
3020	RW	Delay on release 'toff' for relays 'K1' and 'K2'	UINT 16	s	0 ... 99
3021	RW	Repetition time 'test' for automatic device test	UINT 16		0 = OFF 1 = 1 2 = 24 h
3022	RW	Reserved			
3023	RW	Insulation monitoring mode	UINT 16		0 = dc 1 = CHd
3024	RW	Test of the system connection during device test 'nEt'	UINT 16		0 = off 1 = on
3025	RW	Device test during device start 'S. Ct'	UINT 16		0 = off 1 = on

Register	Property	Description	Format	Unit	Value range
3026	RW	Request stop mode (0 = deactivate device)	UINT 16		0 = Stop 1 = ---
3027	RW	Alarm assignment of relay 1 'r1'	UINT 16		Bit 9 ... Bit 1
3028	RW	Alarm assignment of relay 2 'r2'	UINT 16		Bit 9 ... Bit 1
8003	WO	Factory settings for all parameters	UINT 16		0x6661 'fa'
8004	WO	Factory setting only for parameters resettable by FAC	UINT 16		0x4653 'FS'
8005	WO	Start device test	UINT 16		0x5445 'TE'
8006	WO	Clear fault memory	UINT 16		0x434C 'CL'
9800 ... 9809	RO	Device name (ASCII)	UNIT 16		
9820	RO	Software identification number	UINT 16		
9821	RO	Software version number	UINT 16		
9822	RO	Software version: Year	UINT 16		
9823	RO	Software version: Month	UINT 16		
9824	RO	Software version: Day	UINT 16		
9825	RO	Modbus driver version	UINT 16		

RO Read only  
RW Read/Write  
WO Write only

### 5.3.2.2 Alarm assignment of the relays

Several alarms can be assigned to each relay. For the assignment to each relay, a 16-bit register is used with the bits described below. The following table applies to relay 1 and relay 2, in which 'x' stands for the relay number. A set bit activates the specified function.

Bit	Display indication	Meaning
0	Reserved	When reading, always 0 When writing, any value.
1	 x Err	Device error E.xx
2	$rx + R1 < \Omega$	Prewarning R1 - Fault $R_f$ at L+
3	$rx - R1 < \Omega$	Prewarning R1 - Fault $R_f$ at L-
4	$rx + R2 < \Omega$	Alarm R2 - Fault $R_f$ at L+
5	$rx - R2 < \Omega$	Alarm R2 - Fault $R_f$ at L-

Bit	Display indication	Meaning
6	rx U < V	Alarm message $U_n$ - undervoltage
7	rx U > V	Alarm message $U_n$ - overvoltage
8	rx test	Manually started self test
9	rx S.AL	Device start with alarm
10	Reserved	When reading: 0; When writing: any value
11	Reserved	When reading: 0 When writing: any value
12...15	Reserved	When reading: 0; When writing: any value

### 5.3.2.3 Device name

The data format of the device name consists of ten Words with two ASCII characters each.

0x00	0x01	0x02	0x03	0x04	0x05	0x06	0x07	0x08	0x09
------	------	------	------	------	------	------	------	------	------

## 5.4 IsoData data string

In IsoData mode the ISOMETER® sends the entire data string roughly once per second. Communication with the ISOMETER® in this mode is not possible and no additional sender may be connected via the RS-485 bus cable.

IsoData is activated in the menu 'out', menu item 'Adr', when Adr is set to 0. In this case, the 'Adr' symbol flashes on the measured value display.

String	Description
!;	Start symbol
v;	Insulation fault location ' ' / '+' / '-'
1234, 5;	Insulation resistance $R_F$ [k $\Omega$ ]
12345;	System leakage capacitance $C_e$ [nF]
123456;	Reserved
+1234;	Nominal system voltage $U_n$ [V <sub>trueRMS</sub> ] Nominal system voltage type: DC: '+' / '-'
+1234;	Residual DC voltage $U_{L1e}$ [V]
+1234;	Residual DC voltage $U_{L2e}$ [V]
+123;	Insulation fault location -100 ... +100 [%]
123456;	Insulation resistance $R_{FU}$ [k $\Omega$ ]

String	Description
1234;	Alarm message [hexadecimal] (without leading '0x') The alarms are included in this value with the OR function. Assignment of the alarms: 0x0002 device error 0x0004 Prewarning insulation resistance $R_f$ at L+ 0x0008 Prewarning insulation resistance $R_f$ at L- 0x000C Prewarning insulation resistance $R_f$ symmetrical 0x0010 Alarm insulation resistance $R_f$ at L+ 0x0020 Alarm insulation resistance $R_f$ at L- 0x0030 Alarm insulation resistance $R_f$ symmetrical 0x0040 Alarm undervoltage $U_n$ 0x0080 Alarm overvoltage $U_n$ 0x0100 Message system test 0x0200 Device start with alarm
12;	Update counter, consecutively counts from 0 to 99. It increases with the update of the insulation resistance value.
<CR><LF>	String end

## 6 Technical data

### 6.1 Technical data isoCHA425

( )\* = factory settings

#### Insulation coordination acc. to IEC 60664-1/-3

##### Definitions

Measuring circuit (IC1)	L+, L-
Supply circuit (IC2)	A1, A2
Output circuit (IC3)	11, 14, 24
Control circuit (IC4)	E, KE, T/R, A, B

##### Rated impulse voltage

IC1/(IC2-4)	6 kV
IC2/(IC3-4)	4 kV
IC3/IC4	4 kV

##### Rated insulation voltage

IC1/(IC2-4)	400 V
IC2/(IC3-4)	250 V
IC3/IC4	250 V
Pollution degree	3

##### Protective separation (reinforced insulation) between

IC1/(IC2-4)	Overvoltage category III, 600 V
IC2/(IC3-4)	Overvoltage category III, 300 V
IC3/IC4	Overvoltage category III, 300 V

##### Voltage test (routine test) according to IEC 61010-1

IC2/(IC3-4)	AC 2.2 kV
IC3/IC4	AC 2.2 kV

### Supply voltage

Supply voltage $U_s$	AC 100...240 V / DC 24...240 V
Tolerance of $U_s$	-30...+15 %
Frequency range $U_s$	47...63 Hz
Power consumption	$\leq 3 \text{ W}, \leq 9 \text{ VA}$

### IT system being monitored

Nominal system voltage $U_n$	DC 0...400 V
Tolerance of $U_n$	+25 %

### Response values

Response value $R_{an1}$	$R_{an2} \dots 250 \text{ k}\Omega$ (230 k $\Omega$ )*
Response value $R_{an2}$	5 k $\Omega \dots R_{an1}$ (48 k $\Omega$ )*
Hysteresis $R_{an}$	25 %, > 1 k $\Omega$
Undervoltage detection $U <$	10...499 V (off)*
Overvoltage detection $U >$	11...500 V (off)*
Overload detection $U >$	510 V (cannot be deactivated)
Hysteresis $U$	5 %, > 5 V

### System voltage

Measuring range	500 V <sub>RMS</sub>
Display range	0...500 V (measurement True-RMS)
Measurement and relative uncertainty	$\pm 5 \%$ , > $\pm 5 \text{ V}$

### Mode CCS (dc)

Permissible system leakage capacitance $C_e$	$\leq 5 \mu\text{F}$
Measuring and display range $R_F$	1 k $\Omega \dots 2 \text{ M}\Omega$
Measurement uncertainty $R_F$ / relative uncertainty $R_{an}$	$\pm 15 \%$ , $\pm 2 \text{ k}\Omega$
Measuring and display range $C_e$	0...17 $\mu\text{F}$
Measurement uncertainty $C_e$ :	
$R_F < 10 \text{ k}\Omega$	no measurement
$R_F \geq 10 \text{ k}\Omega$	$\pm 15 \%$ , $\pm 0.1 \mu\text{F}$



Response time  $t_{an}$ :

$R_{an} = 2.0 \times R_F$ and $C_e = 1 \mu\text{F}$ acc. to IEC 61557-8	$\leq 10 \text{ s}$
$R_{an} = 2.0 \times R_F$ and $R_F \leq 100 \text{ k}\Omega$	$\leq 10 \text{ s}$

### Mode CHAdEMO (CHd)

 System voltage  $U_n$  measurement from  $U_n \geq \text{DC } 50 \text{ V}$ 

 Permissible system leakage capacitance  $C_e$  per conductor  $\leq 1.6 \mu\text{F}$ 

 Measuring and display range  $R_F$  &  $R_{FU}$  1 k $\Omega$  ... 2 M $\Omega$ 

 Measurement uncertainty  $R_F$  / relative uncertainty  $R_{an}$   $\pm 15 \%$ ,  $\pm 2 \text{ k}\Omega$ 

 Measuring and display range  $C_e$  0...17  $\mu\text{F}$ 

 Measurement uncertainty  $C_e$ :

$R_F < 10 \text{ k}\Omega$	no measurement
$R_F \geq 10 \text{ k}\Omega$	$\pm 15 \%$ , $\pm 0.1 \mu\text{F}$

 Response time  $t_{an}$ :

$R_{an} = 2.0 \times R_{FU}$ and $R_{FU} \leq 100 \text{ k}\Omega$	$\leq 10 \text{ s}$
$R_{an} = 2.0 \times R_F$	$\leq 10 \text{ s}$

### Displays, memory

 Password off / 0...999 (off / 0)\*

 Fault memory alarm messages on/(off)\*

 Display LC display, multifunctional, not illuminated

### Time response

 Start-up delay  $t$  0...10 s (0 s)\*

 Response delay  $t_{on}$  0...99 s (0 s)\*

 Delay on release  $t_{off}$  0...99 s (0 s)\*

### Interface

 Interface / protocol RS-485 / BMS, Modbus RTU, isoData

 Baud rate BMS (9.6 kbit/s), Modbus RTU (selectable),  
isoData (115.2 kbit/s)

 Cable length (9.6 kbit/s)  $\leq 1200 \text{ m}$ 

 Cable: twisted pairs min. J-Y(St)Y 2 x 0.6

Terminating resistor	120 Ω (0.25 W), internal, can be connected
Device address, BMS bus, Modbus RTU	3...90 (3)*

### Switching elements

Switching elements	2 x 1 N/O contact, common terminal 11
Operating principle	N/C operation, N/O operation (N/C operation)*
Electrical endurance under rated operating conditions	10,000 cycles

### Contact data acc. to IEC 60947-5-1

Utilisation category	AC-12 / AC-14 / DC-12 / DC-12 / DC-12
Rated operational voltage	230 V / 230 V / 24 V / 110 V / 220 V
Rated operational current	5 A / 2 A / 1 A / 0.2 A / 0.1 A
Minimum contact load	1 mA at DC ≥ 5 V

### Contact data acc. to UL 508

Rated operational voltage	AC 250 V
Rated operational current	2 A

### Environment/EMC

EMC	IEC 61326-2-4; IEC 61851-21-2:2018-04 Ed. 1.0
-----	---

### Ambient temperatures

Operation	-40...+70 °C <sup>1)</sup>
Transport	-40...+85 °C
Storage	-40...+70 °C

1) Below -25 °C the readability of the display is limited.

### Classification of climatic conditions acc. to IEC 60721 (related to temperature and relative humidity)

Stationary use (IEC 60721-3-3)	3K22
Transport (IEC 60721-3-2)	2K11
Long-term storage (IEC 60721-3-1)	1K22

**Classification of mechanical conditions acc. to IEC 60721**

Stationary use (IEC 60721-3-3)	3M11
Transport (IEC 60721-3-2)	2M4
Long-term storage (IEC 60721-3-1)	1M12

**Connection**
**Screw terminals**

Nominal current	≤ 10 A
Tightening torque	0.5...0.6 Nm (5...7 lb-in)
Conductor sizes	AWG 24...12
Stripping length	8 mm
Rigid / flexible	0.2...2.5 mm <sup>2</sup>
Flexible with ferrules with/without plastic sleeve	0.25...2.5 mm <sup>2</sup>
Multiple conductor rigid	0.2...1.5 mm <sup>2</sup>
Multiple conductor flexible	0.2...1.5 mm <sup>2</sup>
Multiple conductor with ferrules without plastic sleeve	0.25...1.5 mm <sup>2</sup>
Multiple conductor flexible with TWIN ferrules with plastic sleeve	0.25...1.5 mm <sup>2</sup>

**Push-wire terminals**

Nominal current	≤ 10 A
Cross section	AWG 24...14
Stripping length	10 mm
Rigid	0.2...2.5 mm <sup>2</sup>
Flexible without ferrules	0.75...2.5 mm <sup>2</sup>
Flexible with ferrules with/without plastic sleeve	0.25...2.5 mm <sup>2</sup>
Multi-conductor flexible with TWIN ferrules with plastic sleeve	0.5...1.5 mm <sup>2</sup>
Opening force	50 N
Test opening	Ø 2.1 mm

**Other**

Operating mode	continuous operation
Mounting	cooling slots must be ventilated vertically
Degree of protection, built-in components (DIN EN 60529)	IP30
Degree of protection, terminals (DIN EN 60529)	IP20

Enclosure material	polycarbonate
DIN rail mounting acc. to	IEC 60715
Screw mounting	2 x M4 with mounting clip
Weight	≤ 150 g

## 6.2 Standards and certifications

The ISOMETER® was developed in compliance with the standards specified in the Declaration of Conformity.



### EU Declaration of Conformity

Hereby, Bender GmbH & Co. KG declares that the device covered by the Radio Directive complies with Directive 2014/53/EU. The full text of the EU Declaration of Conformity is available at the following Internet address:



[https://www.bender.de/fileadmin/content/Products/CE/CEKO\\_isoXX425.pdf](https://www.bender.de/fileadmin/content/Products/CE/CEKO_isoXX425.pdf)

### UKCA Declaration of Conformity

Hereby, Bender GmbH & Co. KG declares that this device is in compliance with Radio Equipment Regulations 2017 (S.I. 2017/1206). The full text of the UK declaration of conformity is available at the following internet address:



[https://www.bender.de/fileadmin/content/Products/UKCA/UKCA\\_isoXX425.pdf](https://www.bender.de/fileadmin/content/Products/UKCA/UKCA_isoXX425.pdf)

## 6.3 Ordering data

### ISOMETER®

Model	Nominal voltage $U_n$	Article number	
		Push-wire terminals	Screw-type terminals
isoCHA425-D4-4	CCS: DC 0...400 V CHAdEMO: DC 50...400 V	B71036395	B91036395

**Accessories**

Description	Article number
Mounting clip for screw mounting	B98060008
XM420 mounting frame	B990994

**6.4 Document revision history**

Date	Document version	Valid from software version	State/Changes
04.2018	00	D0612 V1.xx	First edition
05.2021	01	D0612 V1.xx	Editorial revision Added: chapter 2.3.11: Note on stopped measuring function Changed: chapter 3.3: Wiring diagram ; chapter 4.2: Menu overview representation Corrected: chapter 7: Value range register 3009, 3011; chapter 9.1: Term 'Necessary minimum contact load', climatic/mechanical classifications, information display range; measured value nominal system voltage in section 'Displays, memory', information undervoltage/overvoltage detection in section 'Response values' Changed: chapter 9.1: Name bus cable in section 'Interface' Added: UKCA certificate Revision history
07.2023	02	D0612 V4.xx	Integration CCS mode ; adaptation to isoCHA425HV ; connection diagram and product image; EU and UKCA Declaration of Conformity ; revision Modbus register table
08.2023	03	"	Editorial revision <ul style="list-style-type: none"> <li>• Transfer to SMC</li> <li>• Better separation of descriptive and instructional texts (Function/ Operation)</li> </ul>



**Bender GmbH & Co. KG**

Londorfer Straße 65  
35305 Grünberg  
Germany

Tel.: +49 6401 807-0  
info@bender.de  
www.bender.de

Alle Rechte vorbehalten.  
Nachdruck und Vervielfältigung nur mit  
Genehmigung des Herausgebers.

All rights reserved.  
Reprinting and duplicating only with  
permission of the publisher.



© Bender GmbH & Co. KG, Germany  
Subject to change! The specified  
standards take into account the edition  
valid until 08.2023 unless otherwise  
indicated.