



MRCDB300 series

AC/DC sensitive residual current monitoring module
for MRCD applications



MRCDB300 series

AC/DC sensitive residual current monitoring module for MRCD applications

This quick-start guide does not replace the manual!

Quick-start guide for the following devices

Type	Supply voltage	Intended purpose	Art. No.	Manual No.
MRCDB301	DC 24V (19,2...28,8V)	Protection of persons (30 mA)	B74043120	D00343
MRCDB302	DC 24V (19,2...28,8V)	Fire protection (300 mA)	B74043121	D00343
MRCDB303	DC 24V (19,2...28,8V)	Freely configurable (30 mA...3 A)	B74043122	D00343
MRCDB304	DC 24V (19,2...28,8V)	Plant protection (300 mA)	On request	D00343
MRCDB305	DC 24V (19,2...28,8V)	Protection of persons (30 mA)	B74043125	D00343

Scope of delivery

- MRCDB30x
- Measuring current transformer core CTBCxx
- Safety instructions
- Quickstart DE/EN



Manual

Intended use

The AC/DC sensitive residual current monitors of type MRCDB30... are used in combination with a CTBC... measuring current transformer core and a circuit breaker according to IEC 60947-2 as additional protection in industrial power supplies. According to IEC 60364-5-53, the use in earthed power supplies (TN and TT systems) up to 800 V is possible. These devices are suitable for monitoring AC and DC fault currents (type B).

Any other use than that described in this document is regarded as improper.

Dimension diagrams MRCDB30... + CTBC... (all dimensions in mm, tolerance ± 0.5 mm)

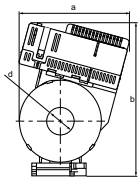

MRCDB30... + CTBC20(P)/CTBC35(P)

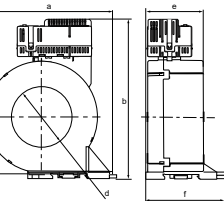
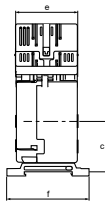

MRCDB30... + CTBC60(P)

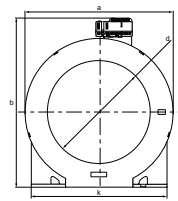

MRCDB30... + CTBC120(P)/CTBC210(P)

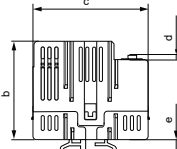
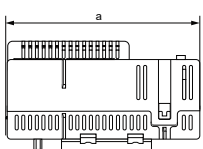
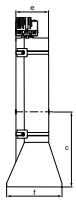

MRCDB30...

Type	a	b	c	d	e	f	g
MRCDB30...-CTBC20(P)	81	112	37	$\varnothing 20$	46	60	
MRCDB30...-CTBC35(P)	97	130	47	$\varnothing 35$	46	61	
MRCDB30...-CTBC60(P)	126	158	57	$\varnothing 60$	56	78	
MRCDB30...-CTBC120(P)	188	232	96	$\varnothing 120$	65	96	139
MRCDB30...-CTBC210(P)	302	346	153	$\varnothing 210$	67	113	277
MRCDB30...	74	37	44	2	4,6		

Dimensions of mountings

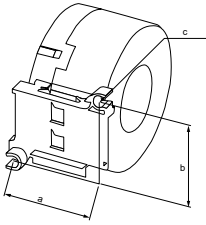

CTBC20(P)/CTBC35(P)

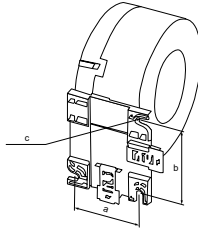

CTBC60(P)

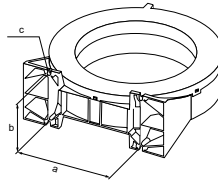

CTBC120(P)/CTBC210(P)

Type	a	b	c
CTBC20(P)	31,4	49	2 x $\varnothing 5,5$
CTBC35(P)	49,8	49	2 x $\varnothing 5,5$
CTBC60(P)	56	66	2 x $\varnothing 6,5$
CTBC120(P)	103	81	4 x $\varnothing 6,5$
CTBC210(P)	180	98	4 x $\varnothing 5,5$

Assembly

A complete residual current monitoring module consists of the MRCDB30x evaluation electronics and a CTBC20(P)...210(P) series measuring current transformer core. If ordered separately, these two components must be plugged together and calibrated during commissioning.

Slide the electronic module onto the plug contacts of the measuring current transformer.

i Avoid repeated plugging and unplugging of the electronics (10 plugging cycles).

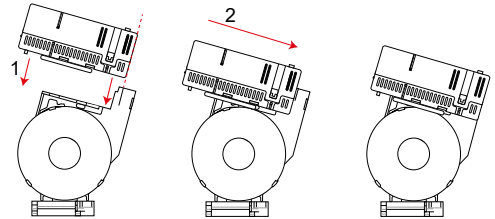

Device view MRCDB30...

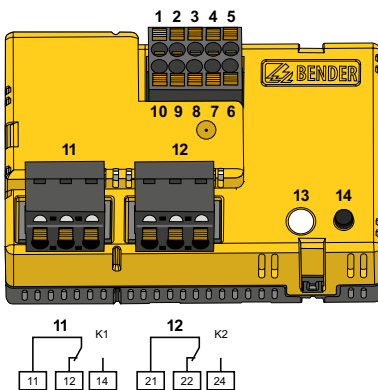

No.	Terminal	Meaning
1	24V	Supply voltage U_S
2	GND	
3	D1	Contact feedback
4	DG	
5	T/R	Connection external test/reset
6	GND	
7	A	RS-485 interface
8	B	
9	X1	Terminals for cable bridge for connection of the integrated terminating resistor of the RS-485 interface
10	X2	
11	11, 12, 14	Relay K1 (prewarning)
12	21, 22, 24	Relay K2 (alarm)
13	–	LED: operation "ON" and "Alarm"
14	–	Test and reset button "T"

Connection - N/C principle with contact feedback

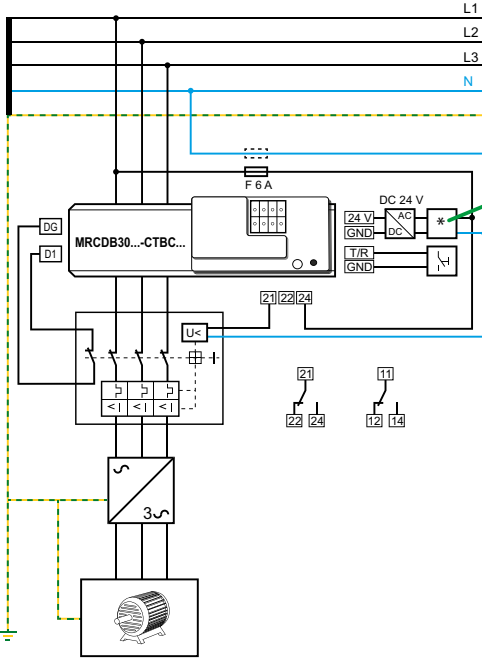

i

For UL applications:
Only use 65/75 °C copper lines!

i

The use of a type 2 surge protection device (SPD) is mandatory due to possible impulse voltages and in order to comply with normative requirements.

The surge protection device must be connected upstream of the power supply unit on the supply side.

Features of the surge protection device:

- Nominal discharge current I_n (8/20 μ s): 20 kA
- Response time: 25 ns
- Two-stage: 1 varistor + 1 spark gap
- Alternatively, the power supply unit must be connected to a CAT II supply without a surge protection device.

Refer to the manual for further connection options.

Commissioning - Modbus RTU

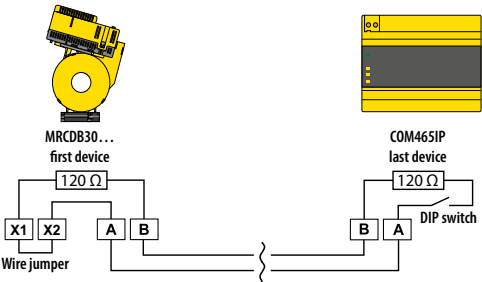

i

Within an interconnection of devices via the RS-485 interface, the first and the last device must each be provided with a terminating resistor. This device-internal resistor can be connected by means of a wire jumper or a DIP switch.

Address setting





i

Every MRCDB3... has a factory-set Modbus address. The address is 1XX, where XX = the last two digits of the serial number. Example: Serial number = 12345678 -> Modbus address = 178

The preset address can be changed via a COMTRAXX gateway, via Modbus or directly on the device.

The address can be changed on the device before installation and offset calibration. The electronic module must not be connected to the measuring current transformer during address setting. Each address in the bus system may only be assigned once.

LED flashing modes

Ⓐ 	slowly	error
Ⓑ 	medium	mode change
Ⓒ 	quickly	ready for address modification
Ⓓ 	slow flashing	address setting mode
Ⓔ 	once	confirmation

System state LED and output relays

The LED indicates the system state by means of colours and lighting/flashing. The changeover contacts of the relay outputs K1 and K2 have defined switching positions for each system state.

System state	GREEN LED ON	RED LED Alarm	Notes	Relay K1	Relay K2
Device switched off	off	off	Device is de-energised, no monitoring, no monitoring function.	de-energised	de-energised
Normal operating state	lights	off	The device is supplied with the specified voltage and monitors the primary circuit. No residual current flows which would lead to tripping.	energised	energised
Prewarning	lights	flashes briefly	The device is supplied with the specified voltage and monitors the primary circuit. A fault current flows which exceeds the set limit of the prewarning.	de-energised	energised
Alarm state	off	lights	The device is supplied with the specified voltage and monitors the primary circuit. A fault current flows which exceeds the set limit of the alarm.	de-energised	de-energised
Device error	off	flashes slowly	The device is supplied with the specified voltage and monitors the primary circuit. An error is detected by the periodic self tests.	de-energised	de-energised
Device in calibration mode	see manual for DC calibration procedure			de-energised	de-energised
Device in address mode	see manual for procedure				
Device signalling	flash quickly in alternation		Modbus register 20006 = 2 Use to detect the device in its environment faster. Is automatically deactivated after one minute.		
Reset	off	flashes slowly	State is reached by pressing and holding the "T" button during alarm state. To perform the reset, release the "T" button when the red LED flashes slowly (1,5...5 s).		
Test	flashes quickly	off	State is reached by pressing and holding the "T" button in normal operating state. To perform the test, release the "T" button when the green LED flashes quickly (5...10 s).	switches	switches

Offset calibration

The residual current monitoring module must be calibrated to the system to be monitored so that the selected protective function can be fulfilled. Each MRCDB30... electronic module must be individually calibrated to the built-in CTBC... measuring current transformer. Calibration can be carried out by means of the "T" button or via the Modbus interface. A calibration must always be performed in case of:

- New installation
- Replacement of a CTBC... measuring current transformer
- Replacement of an MRCDB30... electronic module
- Modification of the response value

In case of response values > 300 mA, no offset calibration is required.

If the device is not calibrated, the LED lights red permanently, commissioning is not possible. Note that during the offset calibration the system is switched off and no current flows through the measuring current transformer.

If a current flows through the measuring current transformer despite the system being switched off, this indicates a device error. Replace the measuring current transformer immediately.

i *The alarm relays switch to safe state during offset calibration (system is switched off).*

Procedure of the first offset calibration

	Action	LED
1	Install the measuring current transformer in the system	off
2	Plug the electronic module and the measuring current transformer together	lights red
3	Disconnect the electronic module from the supply voltage	off
4a	Press and hold the "T" button	off
4b	Press and hold the "T" button, supply the electronic module with supply voltage U_S	lights red permanently (not ready for operation)
		flashes red slowly (A) (ready for calibration)
		flashes red quickly (B) (calibration mode)
5	Start calibration: release "T"	
6	Calibration in progress	flashes red quickly (B)
7	Calibration successful, values are accepted, relay switches	lights green permanently
8	Calibration finished, normal operating status	lights green permanently

Installation instructions measuring current transformer



CAUTION! Device damage due to high induction currents! High currents can be induced into the conductor loop due to the AC/DC sensitive measuring technology used. Do not route protective conductors and low-resistance conductor loops through the measuring current transformer!



CAUTION! Device damage due to interference pulses! The connecting cable (supply, analogue interface...) must not be routed directly past the current transformer core.



CAUTION! Risk of injury due to accessible live conductors! The measuring current transformer must be connected to the corresponding evaluator before the first use and before commissioning of the monitored system.

i **Application in railway vehicles / DIN EN 45545-2:2016!**
 If the horizontal or vertical distance to adjacent components which do not meet the requirements in table 2 of DIN EN 45545-2 is less than 20 mm or less than 200 mm respectively, they are to be regarded as grouped. Refer to DIN EN 5545-2 chapter 4.3 Grouping rules.

i **Do not route any shielded cables through the measuring current transformer.**

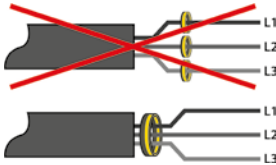

All current-carrying cables must be routed through the measuring current transformer.

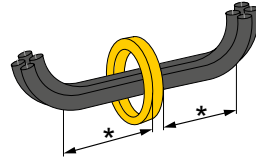

The primary conductors should only be bent from the specified minimum distance. The minimum bending radius specified by the manufacturers for the conductors used must be observed.

* Distance to 90° angle = 2 x outer diameter.

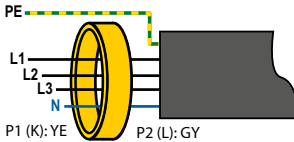

Never route an existing protective conductor through the measuring current transformer.

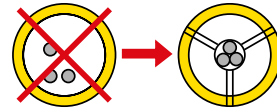

The cables must be aligned with the centre of the measuring current transformer.

Completing and checking installation

The installation must be completed with a functional test: Press the “T” button for 5...10 s.

The system operator is obliged to have the MRCD protective devices checked at regular intervals by an electrically skilled person to ensure that they are functioning properly. This requirement is deemed to be satisfied for normal and environmental conditions if the test intervals mentioned in DGUV V3 (German Social Accident Insurance Regulation 3) are adhered to. The test intervals are to be interpreted in accordance with the risk assessment.

The recurrent tests must include at least the following:

- Testing the environmental conditions for pollution, mechanical damage or insulation damage.
- To trip the circuit breaker, the integrated or the external test button is to be pressed.

Technical data

Rated voltage	800 V
Overvoltage category	III
Nominal supply voltage U_n	DC 24 V
Operating range U_s	± 20 %
Power consumption	≤ 2.5 W
Measuring circuit	
Characteristics acc. to IEC/TR 60755	AC/DC sensitive, type B
Response values I_{dn}	refer to intended purpose on page 2
Prewarning	50 % . . . 100 % I_{dn}

Rated current I_n	
CTBC20 when $I_{dn} \geq 30$ mA	40 A
CTBC20 when $I_{dn} \geq 300$ mA	63 A
CTBC20P	80 A
CTBC35 when $I_{dn} \geq 30$ mA	80 A
CTBC35 when $I_{dn} \geq 300$ mA	125 A
CTBC35P	160 A
CTBC60 when $I_{dn} \geq 30$ mA	160 A
CTBC60 when $I_{dn} \geq 300$ mA	250 A
CTBC60P	320 A

CTBC120 when $I_{dn} \geq 100$ mA.....	330 A
CTBC120P when $I_{dn} \geq 100$ mA.....	630 A
CTBC210 when $I_{dn} \geq 300$ mA.....	630 A
CTBC210P when $I_{dn} \geq 100$ mA.....	630 A
CTBC210P when $I_{dn} \geq 300$ mA.....	1000 A
Measurement accuracy	± 1 % of full scale value
Test winding	yes
Rated continuous thermal current I_{th}	30 A
Rated short-time thermal current ¹⁾ I_{th}	2.4 kA/1 s
Rated dynamic current ¹⁾ I_{dyn}	6 kA/40 ms
¹⁾ refers to the residual current	
Operating uncertainty	± 17.5 %
Relative uncertainty	0...-35 %

Outputs

Outputs	2 changeover contacts
Operating principle.....	configurable, see manual
Switching outputs (K1, K2)	250 V, 5 A
Switching capacity	1500 VA/144 W
Contact data acc. to IEC 60947-5-1	

Rated operational voltage AC	250 V/250 V
Utilisation category	AC-13/AC-14
Rated operational current AC	5 A/3 A
Rated operational voltage DC	220/110/24 V
Utilisation category	DC12
Rated operational current DC.....	0.1/0.2/1 A
Minimum current	10 mA at DC 5 V

Ordering details

Suitable measuring current transformer cores

\varnothing current transformers	Type	Art. No.
20 mm	CTBC20	B98120001
	CTBC20P	B98120002
35 mm	CTBC35	B98120003
	CTBC35P	B98120004
60 mm	CTBC60	B98120005
	CTBC60P	B98120006
120 mm	CTBC120	B98120007
	CTBC120P	B98120020
210 mm	CTBC210	B98120008
	CTBC210P	B98120021

System components

max. connected current transformers	Type	Art. No.
14	STEP-PS/1 AC/24 DC/1.75	B94053111
34	STEP-PS/1 AC/24 DC/4.2	B94053112

Accessories

Type	Art. No.
USB to RS-485 interface converter	B95012045
Terminal set for RCMB module (spare part)	B74043124

EU Declaration of Conformity

The full text of the EU Declaration of Conformity is available via the QR Code:



Bender GmbH & Co. KG

Londorfer Straße 65
35305 Grünberg
Germany

Tel.: +49 6401 807-0
info@bender.de
www.bender.de

Alle Rechte vorbehalten.
Nachdruck und Vervielfältigung nur mit
Genehmigung des Herausgebers.

All rights reserved.
Reprinting and duplicating only with
permission of the publisher.



© Bender GmbH & Co. KG, Germany
Subject to change! The specified
standards take into account the edition
valid until 01/2024 unless otherwise
indicated.